

Best Offices

2026

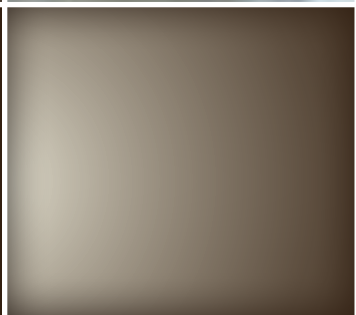

Surplus Office Sales

2131 S Hellman Ave Suite S Ontario, CA 91761

Phone: (909) 947-7770 Fax: (909) 947-4137
www.surplusofficesale.com surplusofficesales@gmail.com

Table of Contents

SYSTEMS

Systems *IN STOCK* 3-13
 Systems *MADE-TO-ORDER* 14-19
 ENGAGE® 20-21

CASEGOODS

Tuxedo 22-26
 Napa 27-39
 StepFront Napa 40-41
 Lodi 42-43
 OSP ASCEND II® Height Adjustable 44-47
 PHAT Tables 48-49
 Sonoma Wood Veneer 50-52
 Townsend Wood Veneer 53-55

TABLES

Tuxedo Conference 56
 Expandable Conference 57
 Napa Conference 58
 Sonoma Wood Conference 59
 Townsend Wood Conference 60
 Training Tables SFT4530 Series 61
 Training Tables 842 Series 62-64

STORAGE & FILING

Laminate Bookcases 65
 Napa 66-67
 Tuxedo 68
 Sonoma Wood Veneer 69
 Townsend Wood Veneer 70-71
 Metal Files 72-73
 Mobile Metal Desks 74-75

RECEPTION / LOUNGE

Desks & Wood Chairs 76-77
 Accent Seating 78-79
 Collections 80-83
 Wall Street Modular 84-85
 Pacific 86-87
 Atlantic 88-89
 Coffee and End Tables 90-91
 SL2900 Series 92
 Healthcare Big & Tall Guest 94-95

OFFICE

Desks 93

SEATING

Executive Leather 96-99
 Mesh 100-105
 24/7 106
 Mesh Task 107-113
 Ventilated Seating 114-117
 Big & Tall 118-123
 Nesting/Training 124-125
 Drafting 126-129
 Executive Office 130-134
 Specialty 135-137
 Faux Leather 138-141
 Traditional 142-143
 Guest/Visitor 144-151
 Self-Skinned Urethane 152-153
 Resin 154-155
 Custom Fabrics 156-159

All natural wood products are subject to variations in color due to wood species, application and finish processes.

Prices subject to change without notice.

List prices are effective at time of publication.

Office Star® Products has participated in the certification of our products to GREENGUARD standards for 10+ years.

Our catalog and its contents are proprietary and copyright of Office Star® Products - February 2026



New ECH14517BT / EXH14517BT series

Systems
IN STOCK

Full-featured, commercial grade



67"H & 53"H White finish & raceways

Systems *IN STOCK* is a unique, contract-quality panel system with sleek, rectilinear design in modern colors. It is a full-featured system with a new flush base built to stringent industry standards. Because it is *IN STOCK* for immediate shipment, we selected neutral Metallic Silver & Gloss White finishes, complementing Drift, a versatile grey/beige fabric. Ensuring long-lasting value, components are constructed with commercial-grade materials. Steel and aluminum feature powdercoat finishes. Backed with a limited lifetime warranty.



*39"H Silver finish
& black raceways
SYSTYP303-S1W*



*39"H White finish,
black raceways
& clear glass
SYSTYP303GC-W1S*

SYSTEMS IN-STOCK

SYSTEMS



SYSTYP201-S1W with Metal Overheads, Shelves & LED Lighting

Features

- 39", 53" & 67"H panels x 5 widths
- 53" & 67"H panels also stocked with framed, tempered glass with contoured, extruded-aluminum frames
- Add-on 14"H glass available clear & frosted; tackboards also available
- Panels feature strong, stress-skin core construction with lightweight durability
- Electrical components are also UL Recognized (UR)
- Overheads and shelves are 100% metal; flipper doors feature a fine-texture finish
- UL Listed

Finishes



SV Silver



WH White

Fabric



01 Drift



SYSTYP101-WW1S

Development included extensive structural joint, worksurface-loading and drawer/pedestal operation testing to ANSI/BIFMA standards.

Flexible solutions, elegant offices & long-term value



SYS-TYP210-W1W



A337272SVS
OSP ASCEND II®
72x72 L-Shape

Sit-Stand Solutions

Add height-adjustable bases to any workstation. Alternate sitting/standing for a healthy and productive workday.



New **OYF222** Dual-Motor 2-Leg Height Adjustable Base; choose White, Silver or Black Base Only Base + 60x30 Top

Worksurface Laminates



WHT White



URB Urban Walnut



SGW Slate Grey



NAS Natty Ash



PCW Park City
NJ Only



ESP Espresso
NJ Only



Installer-friendly rod-and-block assembly for fast, efficient installs.

SYSTYP204G-WW1S

SYSTEMS IN-STOCK

SYSTEMS



6-Pack 39H
SYSTYP603-W1W

Power Your Business

Power is distributed throughout the workstations through 5" flush-design raceways at the base of each panel. Our electrical system is designed specifically for the system and is both UL Listed and CSA Certified. It is an 8-wire, 4-circuit electrical system with 3 open + 1 dedicated circuit. Both ceiling and base-entry power infeeds accommodate up to 40 receptacles. Large-capacity 4-3/4" x 2" raceway accommodates today's technology.



2-Pack 39H
SYSTYP931-W1U

2-Pack 53H
SYSTYP924-W1U

2-Pack 53H Glass
SYSTYP927-W1U



2-Pack 67H
with Flipper
Door Overhead
SYSTYP921-W1U



SYSTYP903-S1E

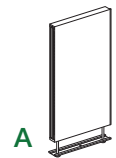

A Panels (Fabric)		
67"H x 24"W	53"H x 24"W	39"H x 24"W
67"H x 30"W	53"H x 30"W	39"H x 30"W
67"H x 36"W	53"H x 36"W	39"H x 36"W
67"H x 42"W	53"H x 42"W	39"H x 42"W
67"H x 48"W	53"H x 48"W	39"H x 48"W

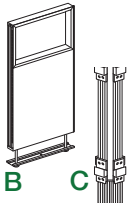

B Panels (Fabric + Glass)		
67"H x 24"W	53"H x 24"W	
67"H x 30"W	53"H x 30"W	
67"H x 36"W	53"H x 36"W	
67"H x 42"W	53"H x 42"W	
67"H x 48"W	53"H x 48"W	

C Connectors: 67, 53 & 39H (2-way, 3-way, 4-way)

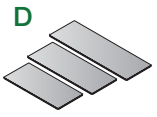

D Worksurfaces		
72"H x 24"D	72"W X 30"D	
66"H x 24"D	66"W X 30"D	
60"H x 24"D	60"W X 30"D	
48"H x 24"D	48"W X 30"D	
42"H x 24"D	72"W X 30"D Bullet	
36"H x 24"D	36"W X 36"D Corner	
30"H x 24"D	42"W X 42"D Corner	
24"H x 24"D		

Transaction Counters		
72"H x 14"D	60"W X 14"D	

Transaction Counter Brackets		
Middle Bracket	Panel/Connector	



E Power System
 Ceiling Feed & Power Pole
 Base Feeds - Left and Right
 Power Bars and Jumpers

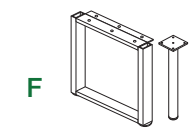

F Worksurface Support Legs	
24"D O-Leg	Single Peninsula Leg
30"D O-Leg	

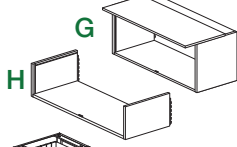

G Metal Overhead Storage w/Flipper Door
 24", 30", 36", 42" & 48" widths

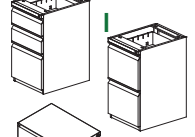

H Metal Hanging Shelf
 24", 30", 36", 42" & 48" widths



I Worksurface Supporting Pedestals (Open Top)	
Box/Box/File	File/File



J Mobile Pedestals (Closed Top)	
Box/Box/File w/Casters	File/File w/Casters
Box/File with Cushion + Casters	Box/File with Casters



K Task Lighting
 24"W LED Task Light (connectable)
 24"W Motion LED Task Light (connectable)

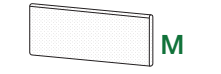

L Clear & Frosted Glass 14"H (Mount on Top of Panel)
 Clear Glass: 24"W, 30"W, 36"W, 42"W & 48"W
 Frosted Glass: 24"W, 30"W, 36"W, 42"W & 48"W

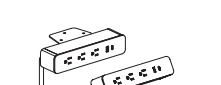

M Fabric Tackboards 11.5"H
 24", 30", 36", 42" & 48" widths



N Power/USB Chargers
 Undersurface & Clamp Mount
 White or Black
 Type-C, Type-A and (3) A/C

Worksurfaces - Rectangular

PWS7230_ _ _	72" x 30"
PWS6630_ _ _	66" x 30"
PWS6030_ _ _	60" x 30"
PWS4830_ _ _	48" x 30"
PWS7224_ _ _	72" x 24"
PWS6624_ _ _	66" x 24"
PWS6024_ _ _	60" x 24"
PWS4824_ _ _	48" x 24"
PWS4224_ _ _	42" x 24"
PWS3624_ _ _	36" x 24"
PWS3024_ _ _	30" x 24"
PWS2424_ _ _	24" x 24"

Worksurfaces - Other

PWS7230BU_ _ _	72" x 30" Bullet
----------------	------------------

5-Sided Corners:

PWS36CNR_ _ _	36" x 36" Corner
PWS42CNR_ _ _	42" x 42" Corner

Transaction Counters:

PWS7214_ _ _	72" x 14"
PWS6014_ _ _	60" x 14"

Worksurfaces Laminates



SGW Slate Grey

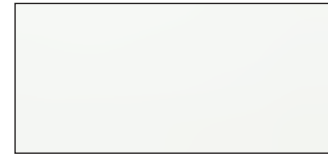

WHT White

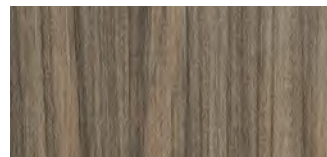

URB Urban Walnut



NAS Natty Ash



PCW Park City
 NJ only



ESP Espresso
 NJ only

Metal Pedestals



PTC22BBF-x
Mobile Box/Box/File Ped
15x21.75x28.25H

Mobile Peds



PTC22FF-x
Mobile File/File Ped
15x21.75x28.25H



PT022BBF-x
Box/Box/File Ped
15x21.75x27.75H

Worksurface-Supporting Peds



PT022FF-x
File/File Ped
15x21.75x27.75H

Features

- 22" deep pedestals
- Factory-built assembled cases/drawers; add casters/glides
- Heavy-gauge steel
- MIG & TIG-welded
- Powdercoat finish
- Random-keyed with replaceable lock cores
- Full-extension file drawers with drop-in front-to-back Letter filing
- Side-to-side Legal filing
- Box drawers are ¾-extension with pencil tray and drawer divider
- Limited lifetime warranty



SV
Silver



WH
White



B
Black



M
Medium Tone



HF
Innertone Light (NJ only)



BXP22BF
A: C:
B: R:

22" Deep Mobile Box/File Pedestal with Cushion
15.75 x 22 x 22.25H

Cushion

- Magnetic attachment
- Silver & White peds with Black fabric; Black peds with Grey fabric
- Available in all OSP custom fabrics and C.O.M. fabrics
- Available in White (WH), Silver (SV) and Black (B)
- All-steel construction
- Powdercoat finish
- Matching drawer interiors
- Legal & Letter filing
- Pencil tray in box drawer
- 5th caster for stability when opening file drawer



PM22BF-x
22" Deep Mobile Box/File Pedestal
15.5 x 22 x 20.5 H

- Available in White (WH), Silver (SV) & Black (B)
- All-steel construction
- Powdercoat finish
- Matching drawer interiors
- Legal & Letter filing
- Pencil tray in box drawer
- 5th caster for stability when opening file drawer

OYF222 Height Adjustable Tables

On Your Feet!

A new high-value, dual-motor/2-stage sit/stand base pairs with the PWS Series tops (see page 7) for extensive size options in our best-selling laminate colors.

Features

- Multiple memory presets
- Width-adjustable to support 48"-72" wide tops
- Supports 24"-30" deep tops
- Weight capacity 220 lbs. (including top)
- Adjusts 27.75" to 47" high
- Moves 25 mm/s
- Less than 50 dB
- White, silver & black finishes



OYF222-WT
Base, White
Base Only

PWS6030-SGW
Top, Slate Grey

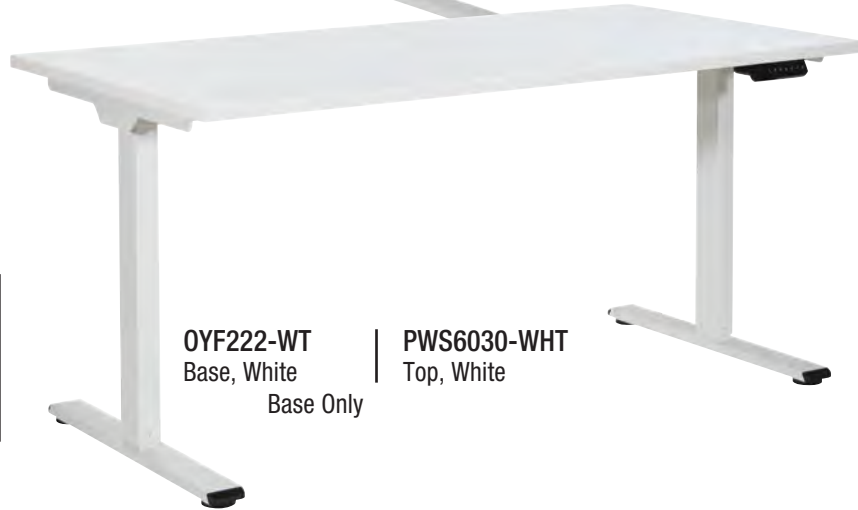

OYF222-WT
Base, White
Base Only

PWS6030-WHT
Top, White



Multiple memory presets



OYF222-WT
Dual-Motor / 2-Stage
Height Adjustable Base,
White
*Shown with 60"W x 30"D Natty Ash Top
More sizes & colors available; see page 7*

Adjusts 27.75" to 47"H
Width-adjustable to
support 48"-72"W tops



Top Colors



URB
Urban Walnut



SGW
Slate Grey

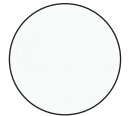

WHT
White



NAS
Natty Ash



ESP
Espresso
NJ Only



PCW
Park City
NJ Only

Base Colors



BK
Black

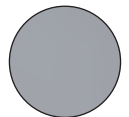

SL
Silver

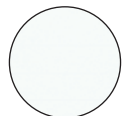

WT
White

SYSTEMS IN-STOCK

3-Way Height Adjustable

SYSTEMS



120° Workstation

OYF1204848SS
120° V-Shape
Silver Base
+ Slate Grey Top



OYF333-BK Black



OYF333-SL Silver



OYF333-WT White

90° Workstation



OYFM7272WWS 90° L-Shape
White Base & Modesty Panel + Slate Grey Tops

Includes:
OYF333-WT Base
PWS7230-SGW 72x30 Top
PWS4824-SGW 48x24 Top
A2MOD72-WHT Modesty Panel

180° Inline



OYF11839BS
 180° Conference/Collaborative Table
 Black Base + Slate Grey Top
\$3,740

Introducing a 3-Leg, 3-Motor Height-Adjustable Base that can be installed in 3 different positions and supports larger tops. We've also added new larger PWS Series tops in key colors.

Tops Colors



SGW
Slate Grey



URB
Urban Walnut

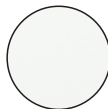

WHT
White

Base Colors



BK
Black

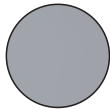

SL
Silver

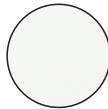

WT
White

Larger Tops

For 180° installations:

PWS7135_ ___ 71" x 35" x 1.5"

PWS9539_ ___ 95" x 39" x 1.5"

PWS11839_ ___ 118" x 39" x 1.5"
(2-Piece Top)

For 120° installations

PWS1204848_ ___ 24" x 48" x 48" x 24"D **\$965**

Features

- 3-Way height adjustable installs in 90°, 120° or 180° positions
- Supports larger top sizes
- Adjusts 22.8" to 48.4"
- Range: 25.6"
- Multiple memory presets
- Weight Capacity 330 lbs. (including top)
- Moves 38mm/s
- Less than 50 dB
- Width adjustable

Recommended Top Sizes

90° = 51.2" - 74.8"

120° = 43.3" - 70.9"

180° = 66.9" - 114.2"

Other sizes will overhang

Workstation Accessories

OYF2WMC

Wire Management Channel, Black
 19.7"W x 3.1"D x 3.5"H

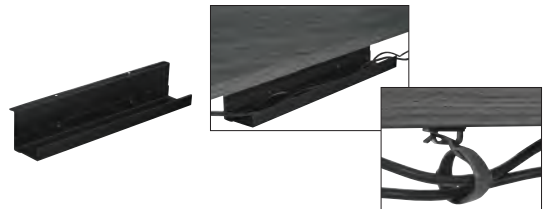

OYF50TIE

6" Cable Tie Hook-and-Loop

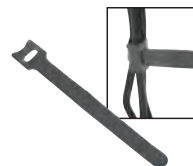

OYF50CLIP

Cable Clip, Adhesive





LTCB6024N
60x24 Table - Black/Natty Ash
Consists of: LTC-B, 2 qty. LSB5-B,
PWS6024-NAS



LTGS6630S
66x30 Table - Silver/Slate Grey
Consists of: LTG-SV,
2 qty. LSB5-B,
PWS6630-SGW

T-Arc Legs



LPGS6030W
60x30 Table - Silver/White
Consists of:
LP30G-SV, 2 qty. LSB5-B,
PWS6030-WHT



LPGS4830S
48x30 Table - Silver/Slate Grey
Consists of:
LP30G-SV, 2 qty. LSB4-B,
PWS4830-SGW

Post Legs 30"D Tops



LPCB3624U
36x24 Table
Black/Urban Walnut
Consists of:
LP24C-B, PWS3624-URB



LPCB4824N
48x24 Table
Black/Natty Ash
Consists of:
LP24C-B, PWS4824-NAS

Post Legs 24"D Tops

T-Arc Legs



LTC-B Casters, Black
LTC-SV Casters, Silver
LTG-B Glides, Black
LTG-SV Glides, Silver
 (2-pack)

Post Legs 30" Tops



LP30C-B Casters, Black
LP30C-SV Casters, Silver
LP30G-B Glides, Black
LP30G-SV Glides, Silver
 (4-pack)

Post Legs 24" Tops



LP24C-B Casters, Black
LP24C-SV Casters, Silver
LP24G-B Glides, Black
LP24G-SV Glides, Silver
 (4-pack)

Top Colors



SGW
Slate Grey



URB
Urban
Walnut

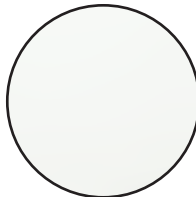

WHT
White



NAS
Natty Ash



ESP
Espresso
NJ Only



PCW
Park City
NJ Only

Tops 30"D

PWS7230 72"x 30"
PWS6630 66"x 30"
PWS6030 60"x 30"
PWS4830 48"x 30"

Tops 24"D

PWS7224 72"x 24"
PWS6624 66"x 24"
PWS6024 60"x 24"
PWS4824 48"x 24"
PWS4224 42"x 24"
PWS3624 36"x 24"
PWS3024 30"x 24"

Support Bars

LSB4-B For 4' Top
LSB5-B For 5' Top
LSB6-B For 6' Top

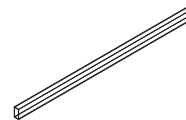

SYSTEMS MADE-TO-ORDER

SYSTEMS



Our **Systems MADE-TO-ORDER** program provides you with an expanded selection to further tailor systems to your project needs. All stock panels can be fabricated in your choice of fabrics. From New Jersey, we offer additional panel sizes and configurations as well as 30+ custom laminates for worksurfaces, pedestals and storage.



Burch PrimeTime Scarlet
#1010086 fabric & Stainless
Custom Laminate worksurfaces
with Black finish

Expanded Design Choices

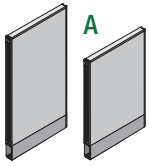

A Panels: Fabric

85"H x 24"W	67"H x 24"W	53"H x 24"W	39"H x 24"W
85"H x 30"W	67"H x 30"W	53"H x 30"W	39"H x 30"W
85"H x 36"W	67"H x 36"W	53"H x 36"W	39"H x 36"W
85"H x 42"W	67"H x 42"W	53"H x 42"W	39"H x 42"W
85"H x 48"W	67"H x 48"W	53"H x 48"W	39"H x 48"W

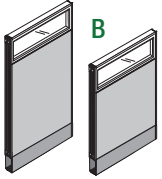

B Panels: Fabric + Glass

67"H x 24"W	53"H x 24"W
67"H x 30"W	53"H x 30"W
67"H x 36"W	53"H x 36"W
67"H x 42"W	53"H x 42"W
67"H x 48"W	53"H x 48"W

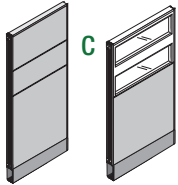

C Panels: Double-Segmented

Double-Segmented Panels are built with either a 52"H or 34"H panel blank, 5"H raceway and (2) 14"H Segments. Segments are either framed clear glass or fabric-covered in your choice of fabric. Fabric & glass segments can be combined in the same panel and stacked per specification.

85"H x 24"W	67"H x 24"W
85"H x 30"W	67"H x 30"W
85"H x 36"W	67"H x 36"W
85"H x 42"W	67"H x 42"W
85"H x 48"W	67"H x 48"W



D Connectors 85,67,53, & 39H / 2-way, 3-way & 4-way

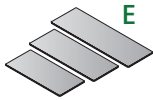

E Worksurfaces - In-Stock

72"H x 24"D	72"W X 30"D
66"H x 24"D	66"W X 30"D
60"H x 24"D	60"W X 30"D
48"H x 24"D	48"W X 30"D
42"H x 24"D	72"W X 30"D Bullet
36"H x 24"D	36"W X 36"D Corner
30"H x 24"D	42"W X 42"D Corner
24"H x 24"D	

Transaction Counters

72"H x 14"D	60"W X 14"D
-------------	-------------

Transaction Counter Brackets

Middle Bracket	Panel/Connector
----------------	-----------------

F Custom Laminate

Custom worksurfaces, pedestals, storage and more available in 30+ custom laminates at additional lead time. Consult your sales rep or project manager for details. Swatches shown on page 19.

G Power System - 8-Way, 4-Circuit

Ceiling Feed & Power Pole	Power Bars & Jumpers
Base Feeds - Left & Right	Receptacles & Data Plates

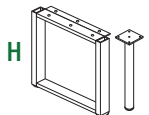

H Support Legs

24"D O-Leg
30"D O-Leg
Single Peninsula Leg

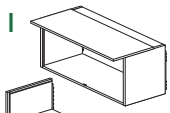

I Metal Overhead Storage w/Flipper Door

24", 30", 36", 42" & 48" widths

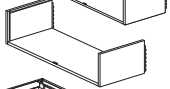

J Metal Shelves

24", 30", 36", 42" & 48" widths

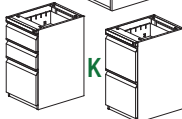

K Worksurface Supporting Pedestals (Open Top)

Box/Box/File & File/File

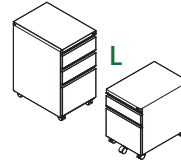

L Mobile Pedestals (Closed Top)

Box/Box/File
File/File
Box/File
Box/File with Cushion



M Task Lighting

24"W LED Task Light (connectable)
24"W Motion LED Task Light (connectable)
24" & 36" Fluorescent Task Lights

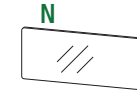

N Clear & Frosted Glass 14"H (Mount on Top of Panel)

24"W, 30"W, 36"W, 42"W & 48"W



O Fabric Tackboards 11.5"H & 15.5"H

24"W, 30"W, 36"W, 42"W & 48"W

Finishes



SV
Silver



WH
White



BU
Black
NJ only



HF
Inertone Light
NJ only

In-Stock Laminates

30+ more Custom Laminates, see page 19



URB
Urban Walnut



WHT
White



SGW
Slate Grey



NAS
Natty Ash



PCW
Park City
NJ Only



ESP
Espresso
NJ Only

In-Stock Fabrics

Many more choices, see page 18



7179
Century Fossil



7180
Century Atlantic

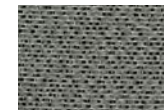

7245
Midway Flint



15-06D
Cascade Blue



YD-19-31
Meadows Drift



19-71A
Nature Valleys

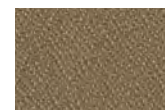

15-17D
Winter Birch Taupe

SYSTEMS MADE-TO-ORDER

SYSTEMS



Burch PrimeTime Spring #1010097 fabric

Full Featured, Commercial Grade

All panels feature strong, stress-skin core construction, resulting in lightweight durability that passes rigid industry standards. Overhead shelves and flipper-door cabinets are constructed with 100% metal materials and fully supported by panels when loaded. The entire system is UL Listed, requiring rigorous testing. In addition, the electrical system is UL Registered, a separate component standard.

Panels are fabricated to order at our California and New Jersey facilities. Special requests are accommodated whenever possible; contact your project manager with any special requests.

Panel Heights: 85", 67", 53" & 39"

Panel Widths: 24", 30", 36", 42" & 48"

Worksurfaces: 15 sizes of stock laminates;
any size/shape in custom laminates

Frameless clear and frosted glass can be mounted to the top of a panel for an alternative aesthetic.



Segmented panel design provides you with the design freedom to create one-of-a-kind aesthetics. Our 14”H segments are available in framed/clear glass and in any fabric.

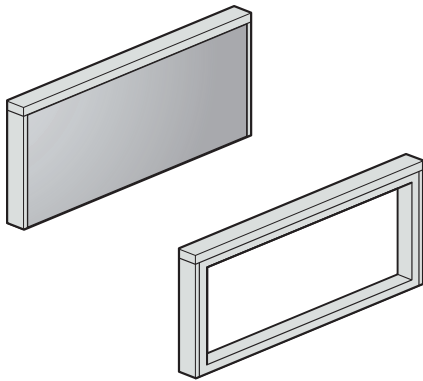

Panels can be constructed with segments single-stacked, double-stacked or combined for a myriad of possibilities. Each segment attaches with a metal panel/segment joiner in matching paint finish. Together, this creates the appearance of a frame-and-tile system in a contemporary, thin-profile design and at substantial savings.



Single-segment panels are available 53”H or 67”H. Double-segmented panels are available 67”H or 85”H.



Burch Ace Mint #1010529 fabric & Ash Custom Laminate worksurfaces with Innertone Light finish

SYSTEMS MADE-TO-ORDER

Vertical Surface Fabrics We can upholster panels in any commercial fabric. Here, we highlight some popular patterns/colors from Burch & Duvaltex available at Grade 2 & 3 pricing. You can visit their websites for the full color range of each pattern, additional patterns and memo samples. Additional lead time is required. For C.O.M. fabrics, send a memo sample with your quote for confirmation and yardage requirements (priced at Grade 1).

Prime Time *Grade 2*



Silverado 1012188



Elephant 1010102



Sterling 1010616



Parchment 1010104



Cinder 1010103

Coalition *Grade 2*



Iced 7128

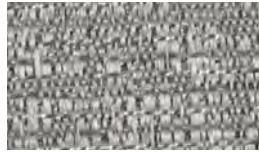

Heirloom 7131



Rain 1009378



Champagne 1009382

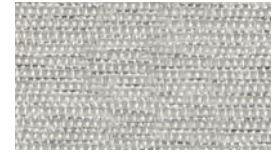

Sterling 1009377

Tier *Grade 2*

Ace *Grade 2*



Platinum 1010536



Falcon 1010535



Biscotti 1010539



Mint 1010529

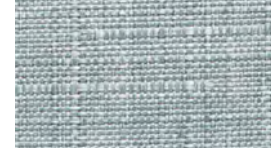

Drizzle 1010528

Theory *Grade 3*



Bisque 033



Cotton 040



Pewter 031



Marina 050



Ash 2634

Essence *Grade 2*

Expanse *Grade 3*

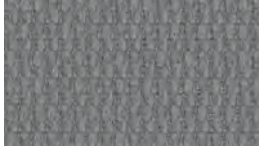

Morel 046

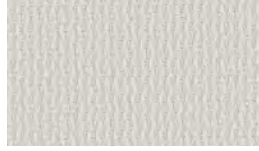

Opaline 041



Breeze 051

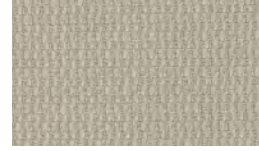

Sand 042



Cream 2631

Reeds *Grade 3*



Greystone 020

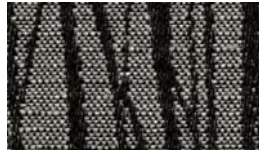

Iron 030

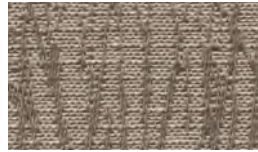

Mink 050



Bisque 010



Heather 2633

Custom Laminates expands your choices with 30+ additional laminate selections available on our standard worksurfaces and much more! We can custom-quote any size/shape worksurfaces, pedestals, storage units and more. Orders require 25 quantity minimum and additional lead time. You will receive product on a separate shipment.

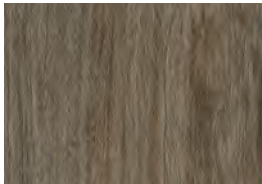

Southwest



GreyLikeaTree



Silverwood



White Chocolate



Hardrock Maple



Natural Maple



Graphite Wood



Shadow



Mist



Latitude



Pearl



Midnight



Laurentian



Nutmeg



Grigio



Tuxedo



Walnut



Espresso



Dark Rum



Cappuccino Cherry

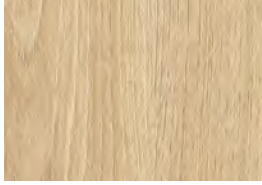

Solana

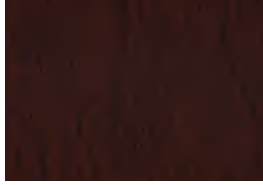

Mahogany Impression



Shiraz Cherry



Skyline

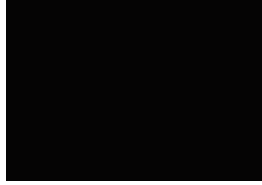

Black

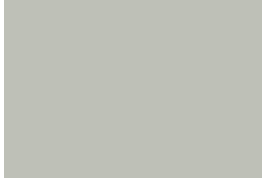

Light Grey



Charcoal



Ash



White

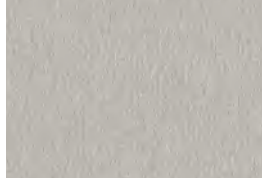

Stainless



Features

- Rock-solid Silver and White frames in 4', 5' & 6' increments
- Supports 24"D & 30"D tops
- Triple-ply PET divider screens are tackable and acoustical
- Integrated metal center channel with ample room for power/data wires/cables
- Daisy-chainable 4-circuit power system
- Desk-height power and power/USB modules



Double-Sided | Collaborative Spaces

24D Tops	2-persons w/Screen	4-persons w/Screens	6-persons w/Screens
4'W			
5'W			
6'W			
30D Tops	2-persons w/Screen	4-persons w/Screens	6-persons w/Screens
4'W			
5'W			
6'W			



Single-Sided	
CMB1PP2448	48 x 24
CMB1PP2460	60 x 24
CMB1PP2472	72 x 24

Single Add-On	
CMB1PE2448	48 x 24
CMB1PE2460	60 x 24
CMB1PE2472	72 x 24

Divider Screens	
CMBDS48	48"
CMBDS60	60"
CMBDS72	72"

Screen Hardware - Single	
CMBDSHWKS	

Single-Sided | Space-Efficient

24D Tops	1-person w/Screen	2-persons w/Screens	3-persons w/Screens
4'W			
5'W			
6'W			
30D Tops	1-person w/Screen	2-persons w/Screens	3-persons w/Screens
4'W			
5'W			
6'W			

Frames



SV Silver WH White

Divider Screens



GR Graphite SP Salt & Pepper
EB Ebony CS Cashmere

Worksurfaces



SGW Slate Grey WHT White



NAS Natty Ash URB Urban Walnut



PCW Park City - *NJ Only* ESP Espresso - *NJ Only*

Double-Sided

CMB2PP4848	48 x 48
CMB2PP4860	60 x 60
CMB2PP4872	72 x 60

Double Add-On

CMB2PE4848	48 x 48
CMB2PE4860	48 x 60
CMB2PE4872	48 x 72

Divider Screens

CMBDS48	48"
CMBDS60	60"
CMBDS72	72"

Screen Hardware - Double

CMBDSHWKD

Worksurfaces 24"D

PWS4824-xxx	48 x 24
PWS6024-xxx	60 x 24
PWS7224-xxx	72 x 24

Worksurfaces 30"D

PWS4830-xxx	48 x 30
PWS6030-xxx	60 x 30
PWS7230-xxx	72 x 30



CMB Power System

- 4-circuit / hardwire power
- Daisy-chainable
- Fits ENGAGE®
- 48/60/72 jumpers
- Desktop A/C & AC/USB modules
- Up to 8-10 duplex outlets from a single feed, depending on local code



U-Shape with Right Bridge + Hutch 72 x 114 TUXSGW-TYP12RG

Features

- Contract-grade laminates are accented with Silver reveal and base trim, aluminum finish drawer pulls and frosted glass/aluminum frame modesty panels and hutch doors.
- Silver-finish dual-electric, dual-USB power unit is standard in all bridges, returns and table tops to instantly power office technology.
- Desk pedestals have legal-width drawers.
- Full depth pedestals and full-height modesty panels are standard. Pedestals include single-key, side locking.
- Modular table components create 48" round, 48" square and expandable rectangular conference tables. Tables feature standard dual-electric, dual-USB power unit with 3-way wire management in all table bases.



Tuxedo Standard Pulls

Optional Pulls



DPT5L00-B
Black (5-pack)



DPT5L00-S
Silver (5-pack)



DPT5BAR-B
Black (5-pack)



DPT5BAR-S
Brushed Silver (5-pack)



Double Pedestal Desk 72 x 36
TUXSGW-TYP2



Shown: L-Shape with Right Return 66 x 78
TUXSGW-TYP9R



U-Shape with Left Bridge 72 x 114
TUXSGW-TYP22L

White-Slate Grey



Rectangular Conference Table 96x48 TUXWHTSGW-60 | 920350C-R107 Chair



U-Shape with Left Bridge + MultiFile 72 x 114
TUXWHTSGW-TYP53L \$7,675

- Shown:
- 2-Door Storage Cabinet
TUXWHTSGW-13
- 2-Drawer Lateral File
TUX-12-WHTSGW
- 3-Shelf Bookcase/Open Hutch
TUX-55-SGW

TUXEDO Dark Roast

CASEGOODS



L-Shape with Bow Front Desk + Right Return 72 x 90 TUXDKR-TYP8R



U-Shape with Right Bridge + Lateral File 72 x 114 TUXDKR-TYP52R



Double Pedestal Desk 66 x 30 TUXDKR-TYP3



Double Pedestal Credenza 72 x 24 TUXDKR-TYP5



Shown: Right L + Hutch 72x72 TUXDKR-TYP231R



Bow Front Double Pedestal Desk 72 x 42 TUXDKR-TYP1

Park City



Executive Office TUXPCW-TYP11G



L-Shape w/Bow Front Desk + Right Return 72 x 90 TUXPCW-TYP8R



Worksurface-height power unit with dual-electric, dual-USB plug-ins (silver finish)

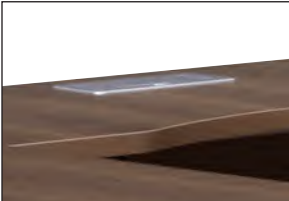

Paper shelves



Silver, solid-metal drawer pulls

TUXEDO TYPICALS

CASEGOODS

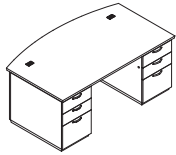

Bow Front Double Pedestal Desk
TUXxxx-TYP1 72x42
 TUX-89, 65L, 65R

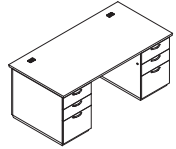

Double Pedestal Desk
TUXxxx-TYP2 72x36
 TUX-01, 65L, 65R
TUXxxx-TYP3 66x30
 TUX-02, 63L, 63R

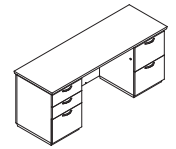

Double Pedestal Credenza
TUXxxx-TYP5 72x24
 TUX-43, 66L, 75R

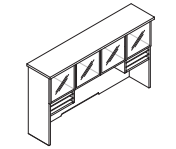

Hutches 72x16x42H
TUXxxx-42 Glass Doors
 TUX-44H, 4DG (shown)
TUXxxx-44 Wood Doors
 TUX-44H, 4DW (not shown)

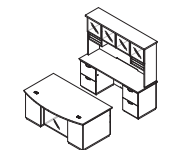

Executive Office
TUXxxx-TYP11G Dsk/Crednz/Hutch
 TUX-89, 65L, 65R, 43, 75L, 75R, 44H, 4DG

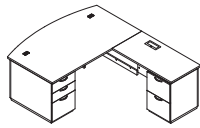

Bow Front L-Shape 72x90
TUXxxx-TYP8R Right Return
 TUX-89, 65L, 45R, 71R, 75R (shown)
TUXxxx-TYP8L Left Return
 TUX-89, 65R, 45L, 71L, 75L (not shown)

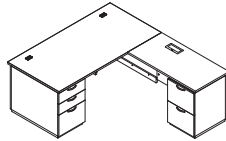

L-Shape Desk 66x78
TUXxxx-TYP9R Right Return
 TUX-02, 63L, 67R, 45R, 75R (shown)
TUXxxx-TYP9L Left Return
 TUX-02, 63R, 67L, 45L, 75L (not shown)

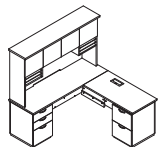

L-Shape + Hutch 72x72
TUXxxx-TYP231R Right Return
 TUX-43, 66L, 45R, 75R, 44H, 4DW (shown)
TUXxxx-TYP231L Left Return
 TUX-43, 66L, 45L, 75R, 44H, 4DW (shown)

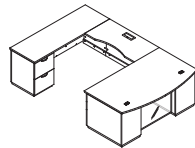

Left U-Shapes 72x114
TUXxxx-TYP22L FF Crdnza Ped
 TUX-89, 65R, 71L, 70, 43, 75L (shown)
TUXxxx-TYP52L Lat File Ped
 TUX-89, 65R, 71L, 70, 43, 12NT
TUXxxx-TYP53L MultiFile Ped
 TUX-89, 65R, 71L, 70, 43, 69NT

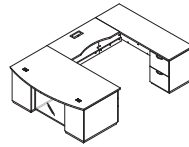

Left U-Shapes 72x114
TUXxxx-TYP22R FF Crdnza Ped
 TUX-89, 65L, 71R, 70, 43, 75R (shown)
TUXxxx-TYP52R Lat File Ped
 TUX-89, 65L, 71R, 70, 43, 12NT
TUXxxx-TYP53R MultiFile Ped
 TUX-89, 65L, 71R, 70, 43, 69NT

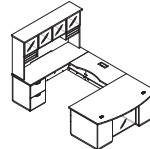

U-Shape + Hutch 72x114
TUXxxx-TYP12LG Left Bridge
 TUX-89, 65R, 71L, 70, 43, 75L, 44H, 4DG (shown)
TUXxxx-TYP12RG Right Bridge
 TUX-89, 65L, 71R, 70, 43, 75R, 44H, 4DG

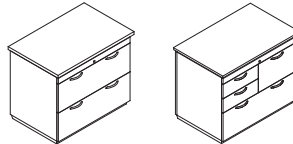

Filing 36x24x30H
TUX-12 2-Drwr Lateral File
TUX-69 MultiFile Cabinet

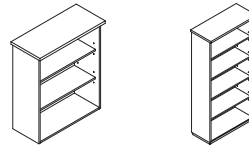

Bookcases
TUX-55 3 Shelves
 36x14x42H
TUX-56 5 Shelves
 36x14x72H

Storage
TUX-13
 2-Door Cabinet
 36x24x30H

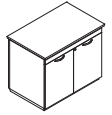

TUXxxx-TYP207
 4-Dr Cabinet
 72x24x30H

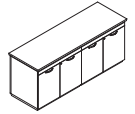

TUXxxx-TYP205
 LatFile/Storage
 72x24x30H

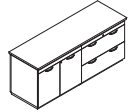

TUXxxx-TYP204
 MultiFile/Storage
 72x24x30H

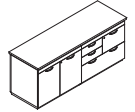

TUXxxx-TYP206
 MultiFile/Storage
 72x24x30H

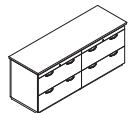

Available Finishes



SGW
 Slate Grey



WHTSGW
 White Top
 Slate Grey Base



DKR
 Dark Roast



PCW
 Park City



Silver-finish dual-electric, dual-USB power unit



Aluminum finish drawer pulls



Silver reveal and base trim



Frosted glass/Aluminum frame

Tuxedo Standard Pulls



Optional Pulls



DPT5L00-B
 Black (5-pack)

DPT5L00-S
 Silver (5-pack)

DPT5BAR-B
 Black (5-pack)

DPT5BAR-S
 Brushed Silver (5-pack)

NAPA COLLECTION

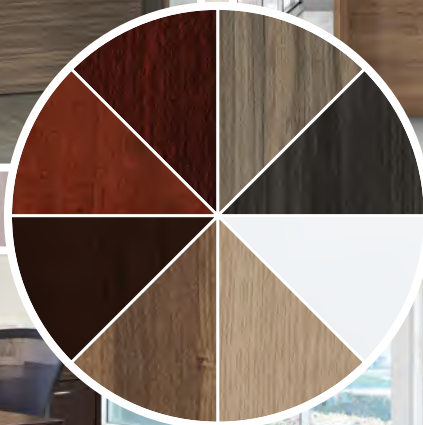

Cherry • Mahogany • Urban Walnut • Slate Grey • White • Natty Ash • Park City • Espresso



NAPURB-TYP15L Left U w/Bullet Corner Desk + Storage & (2) Full Pedestals 107x107

Napa

combines extensive selection, capability and value to provide long-term solutions to your office environment. Modular designed laminate casegoods provide flexibility now and in the future. Most units are non-handed, adjusting to various office layouts, users and changes.

Features

- Full 1-1/8" thick worksurfaces and 2" thick conference table tops
- Impact-resistant 3mm PVC edges with hand-detailed, triple-groove style
- High-grade, contract-quality laminates
- CARB & TSCA compliant materials
- GREENGUARD certified for low emissions



All Napa drawers have matching interiors.



NAPURB-TYP1 Bow Top Double Ped Desk
Includes NAP-65 Box/Box/File & NAP-74 File/File Pedestals
5700E Chair



NAPURB-TYP3 66x30 Double ¾ Ped Desk
NAPURB-TYP4 60x30 Double ¾ Ped Desk
Includes NAP-80 Box/File Pedestals



Urban Walnut



NAPURB-TYP8 L-shape with Bow Top Desk & (2) Full Pedestals 71x89



NAPURB-TYP11 Executive Office with (4) Full-Height Pedestals

Napa Standard Pulls



Black Pulls are standard on CHY, MAH, NAS, SGW, URB & WHT Napa. Also available in a 10-Pack NAP-PB



Metallic Pulls are standard on ESP & PCW Napa. Also available in a 10-Pack NAP-PM

Optional Pulls



DPN5BOW-B
Black

DPN5BOW-S
Silver Metallic (shown)
(5-Pack)



DPN5CRE-B
Black (shown)

DPN5CRE-S
Silver Metallic
(5-Pack)



DPN5BAR-B
Black
(5-Pack)

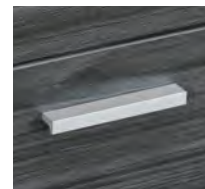

DPN5BAR-S
Brushed Silver
(5-Pack)



PM7102B

Grommet Charger
Includes:
(2) USB Type-C
& (1) A/C ports



PM7102W

Fits Napa grommet hole without pedestal mounted below.



NAPSGW-TYP12 U-Shape w/Hutch & (2) Full Pedestals 71x113

Features

- Wire management grommets standard
- Drawers/doors can be keyed alike or different
- 5-sided drawer construction
- Full-extension, steel ball-bearing drawer slides
- All-metal filing hardware pre-installed
- Coordinating wood chairs, expandable tables, height adjustable tables and much more



52"H Storage Cabinet
24x24x52H
NAP-161-SGW



Mobile pedestals feature concealed caster design.

Reception Station and (2) Hanging Box/File Peds
71x77x42H
NAPSGW-TYP19
515-F37N1F2 Chair





NAPURB-TYP16 U w/Bullet Desk+Hutch+Bookcase & (1) Full Pedestal 107x108 | FL90071C-U6 Chair



47" Round Table NAP-23-SGW | 920351C-R105 Chair



NAPSGW-TYP9 L-Shape with (2) Full Pedestals 66x78
5700E Chair

Napa Standard Pulls



Black Pulls are standard on CHY, MAH, NAS, SGW, URB & WHT Napa. Also available in a 10-Pack NAP-PB



Metallic Pulls are standard on ESP & PCW Napa. Also available in a 10-Pack NAP-PM

Optional Pulls



DPN5BOW-B
Black
DPN5BOW-S
Silver Metallic (shown)
(5-Pack)



DPN5BAR-B
Black
(5-Pack)



DPN5CRE-B
Black (shown)
DPN5CRE-S
Silver Metallic
(5-Pack)

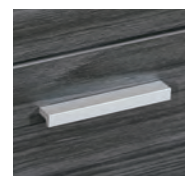

DPN5BAR-S
Brushed Silver
(5-Pack)



NAPESP-TYP18L U w/Left Corner Bullet Desk, Hutch & (1) File/File Pedestal 71x101 | 515-F37N1F2 Chair



4-Drawer Lateral File
36x22.5x53H
NAP-109-ESP

Double Full Pedestal
Desk 71x35
NAPESP-TYP2

5700E Chair



NAPESP-TYP29G L-Shape with Glass Modesty Panel & (1) Box/Box/File Pedestal 71x84



Storage Cabinet
24x24x65H
NAP-152-ESP



2-Drawer Lateral File
NAP-12-ESP
Open Hutch
NAP-53-ESP



PM7102B



PM7102W

Grommet
Charger
Includes:
(2) USB Type-C
& (1) A/C ports

Fits Napa grommet hole without pedestal mounted below.



White



NAPWHT-TYP13 U-Shape w/Glass-Door Hutch+Storage & (2) Full Peds 108x113



Reception Desk Shell	71 x 35.75/30 x 41.5	NAP-122-WHT
Glass Floating Top	71 x 17.5 x 0.5	NAP-123
BBF Pedestal	15.5 x 22.25 x 28.25	NAP-65-WHT
FF Pedestal	15.5 x 22.25 x 28.25	NAP-74-WHT



42 Round Table NAP-27-WHT
65H 5-Shelf Bookcase NAP-56-WHT



5-Shelf Storage Cabinet with Two Doors
NAP-156-WHT



NAP-89, 156, 43/65/74, 42+HO-BLK, 13/212DW | 32-E33P918PHL Chair



L-Shape w/Glass Modesty Panel 71 x 84 NAPNAS-TYP29G



U Shape w/Hutch 71 x 113 NAPNAS-TYP12



Reception Station 71 x 77 x 42H NAPNAS-TYP19
67-37N1G5-F8 Chair w/Custom Fabric



Right U + Bookcase 107 x 107 NAPNAS-TYP14R



Park City



NAPPCW-TYP11 Executive Office with (4) Full Pedestals

| 62200C-R107 Chair



Double Full Pedestal
Credenza 71x24
NAPPCW-TYP5

NAPTБ-3 Tackboard
fits 71" Hutches Black
Fabric In Stock
Custom Fabrics available



Napa Standard Pulls



Black Pulls are standard on CHY, MAH, NAS, SGW, URB & WHT Napa. Also available in a 10-Pack NAP-PB



Metallic Pulls are standard on ESP & PCW Napa. Also available in a 10-Pack NAP-PM

Optional Pulls



DPN5BOW-B
Black
DPN5BOW-S
Silver Metallic
(shown)
(5-Pack)



DPN5BAR-B
Black
(5-Pack)



DPN5CRE-B
Black (shown)
DPN5CRE-S
Silver
Metallic
(5-Pack)



DPN5BAR-S
Brushed
Silver
(5-Pack)



Right L-Shape with Curved Corner Desk
and (2) Full Pedestals 71x83
NAPPCW-TYP10R \$3,070



NAP-WM36-CHY
(2 qty.)

Above: 72x72 L-Shape includes NAP-82R, 92 & 80

Also: NAP-WM36-CHY Wall-Mount Overhead w/Wood Doors each x 2 qty.



2-Drawer Lateral File
NAP-12-CHY



MultiFile Pedestal
NAP-69-CHY



RaceTrack Tables 6', 8', 10' & 12' available
NAP-36-CHY 8' Table 95x44x29H

Napa Pedestals



Box/Box/File
Unfinished top
NAP-65-CHY



File/File
Unfinished top
NAP-74-CHY



Box/File 22D
NAP-80-CHY



Box/File 18D
NAP-76-CHY



Mobile Pedestals
Box/Box/File
NAP-85-CHY



Mobile Pedestals
File/File
NAP-86-CHY



Mahogany



66x78 L-Shape+Hutch includes NAP-02, 45, 80 & 39



Storage Cabinet 35.5 x 22.25 x 29
NAP-13-MAH



Bow Desk Shell 71 x 41 x 29
NAP-89-MAH



Round Table 47" Dia. x 29
NAP-23-MAH



Storage Credenza 71 x 22.25 x 29 NAPMAH-110



5-Shelf Bookcase 35.5x14x65H
NAP-56-MAH

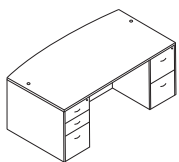

Bow Top Desk 71x41
NAPxxx-TYP1

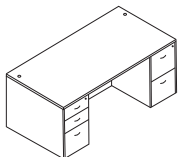

Double Pedestal Desk 71x35
NAPxxx-TYP2

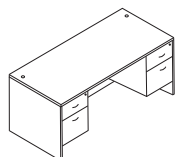

Double Pedestal Desk 66x30
NAPxxx-TYP3

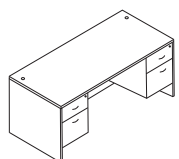

Double Pedestal Desk 60x30
NAPxxx-TYP4

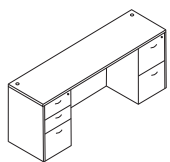

Kneespace Credenza 71x24
NAPxxx-TYP5

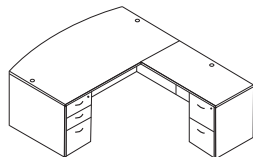

L Shape w/Bow Top Desk 71x89
NAPxxx-TYP8

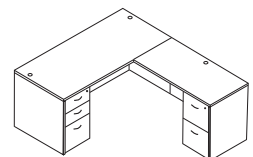

L Shape 66x78
NAPxxx-TYP9

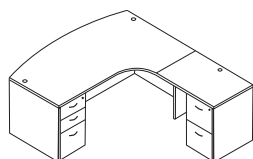

Right L Shape w/Curved Corner
NAPxxx-TYP10R

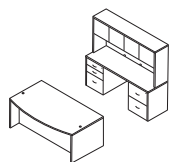

Executive Office
NAPxxx-TYP11

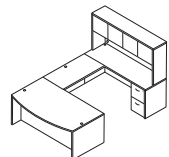

U Shape w/Hutch 71"x113"
NAPxxx-TYP12

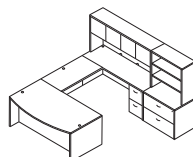

U Shape w/Hutch + Storage
108x113
NAPxxx-TYP13

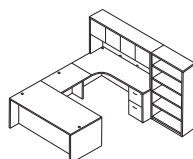

Right U + Bookcase 107x107
NAPxxx-TYP14R

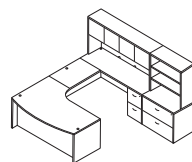

Right U w/Corner + Storage
107x107
NAPxxx-TYP15R

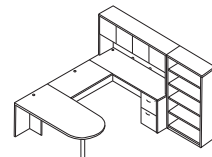

U w/Bullet + Bookcase 107x108
NAPxxx-TYP16

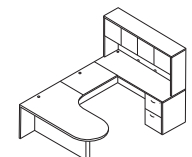

U w/Right Corner Bullet 71x101
NAPxxx-TYP18R

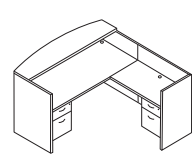

Reception Station 71x77x42H
NAPxxx-TYP19

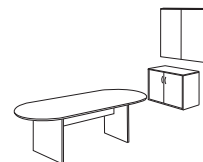

Conference Group 3 pcs.
with 8' Table
NAPxxx-TYP20

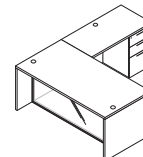

L-Shape w/Glass Modesty Panel
71x84
NAPxxx-TYP29G

ACCESSORIES

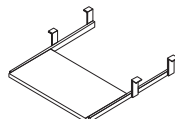

Keyboard Tray
NAP-14-xxx

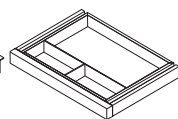

Center Drawer
NAP-15-xxx

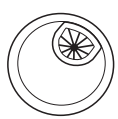

Metallic Grommets
(5-pack) NAP-GM



Lock Core w/Keys
LK1-GC
Change Key
KC-GC
Master Key
KM-GC



Grommet Charger
PM7102B Black
PM7102W White
Fits Napa grommet hole without pedestal mounted below.

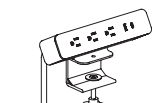

Power Charger,
Clamp Mount
PM5311B Black
PM5311W White

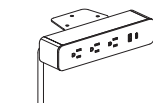

Power Charger,
Undersurface Mount
PM8311B Black
PM8311W White

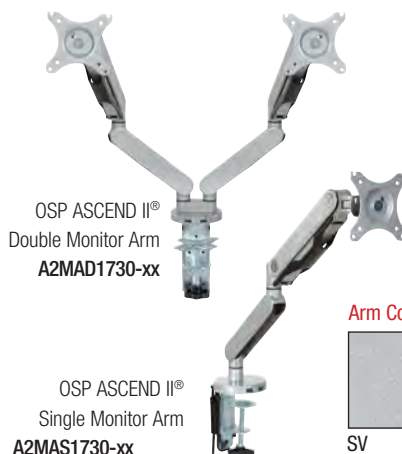

OSP ASCEND II® Gas-Assist Monitor Arms with Dual USB Ports

OSP ASCEND II®
Double Monitor Arm
A2MAD1730-xx

OSP ASCEND II®
Single Monitor Arm
A2MAS1730-xx

Arm Colors



SV
Silver



BK
Black



WH
White

Napa Standard Pulls



Black Pulls are standard on CHY, MAH, NAS, SGW, URB & WHT Napa. Also available in a 10-Pack NAP-PB



Metallic Pulls are standard on ESP & PCW Napa. Also available in a 10-Pack NAP-PM

Optional Pulls



DPN5BOW-B
Black
DPN5BOW-S
Silver Metallic
(shown)
(5-Pack)



DPN5CRE-B
Black (shown)
DPN5CRE-S
Silver
Metallic
(5-Pack)



DPN5BAR-B
Black
(5-Pack)

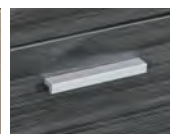

DPN5BAR-S
Brushed
Silver
(5-Pack)



Has achieved GREENGUARD certification

ITEMS

DESKS

NAP-89-xxx	71x41x29H
NAP-01-xxx	71x36x29H
NAP-101-xxx	71x30x29H
NAP-02-xxx	66x30x29H
NAP-03-xxx	60x30x29H
NAP-21-xxx	48x30x29H
NAP-22-xxx	48x24x29H

Glass Modesty Panel

NAP-88	71x36x29H
Fits NAP01, NAP87L, NAP87R, NAP89, NAP101	

Bullet Desk

NAPxxx-47	71x36x29H
-----------	-----------

Corner Desk

NAP-87TL-xxx	71x36/48x29H
NAP-87TR-xxx	71x36/48x29H

Computer Corner Bullet

NAPxxx-57L	71x30/42x29H
NAPxxx-57R	71x30/42x29H

Corner Unit

NAP-83-xxx	42x42x29H
------------	-----------

RETURNS

NAP-45-xxx	47x23.5x29H
NAP-96-xxx	42x23.5x29H
NAP-46-xxx	42x20x29H
NAP-92-xxx	36x23.5x29H

BRIDGES

NAP-70-xxx	47x23.5x29H
NAP-98-xxx	42x23.5x29H
NAP-93-xxx	35x23.5x29H

Items marked **
not available in White (WHT).

Available Finishes



CREDENZAS

NAP-43-xxx	71x24x29H
NAP-11-xxx	66x24x29H
NAP-08-xxx	60x24x29H
Support Leg (2-pk)	
NAP-SL2-xxx	71x24x29H

Corner Credenza

NAP-82L-xxx	71x36x29H
NAP-82R-xxx	71x36x29H

Storage Credenza

NAPxxx-110	71x22.5x29H
------------	-------------

PEDESTALS

NAP-65-xxx	BBF Ped	15.5x22.25x28.25H	
NAP-74-xxx	FF Ped	15.5x22.25x28.25H	
NAP-69-xxx	MultiFile Ped	30.25x22.25x29H	
NAP-85-xxx	Mobile BBF Ped	15.5x22.25x28H	
NAP-86-xxx	Mobile FF Ped	15.5x22.25x28H	
NAP-76-xxx	(for NAP-46 Return)	Hanging Ped	15.25x18.5x20.75H
NAP-80-xxx	Hanging BF Ped	15.25x22.25x20.75H	

STORAGE & FILING

NAP-55-xxx	3-Shelf Bookcase	35x14x42H
NAP-56-xxx	5-Shelf Bookcase	35x14x42H

NAP-253-xxx	36"H Quarter Round	Open Hutch	15x15x36H
NAP-254-xxx	29"H Quarter Round	Bookcase	24x24x29

NAP-13-xxx	Storage Cabinet	35.5x22.25x29H
NAP-12-xxx	Lateral File	35.5x22.25x29H

NAP-T1213-xxx	NAP12/13 Combo Top	71x22.5
---------------	--------------------	---------

NAP-109-xxx	4-Drwr Lat File	36x22.5x53
-------------	-----------------	------------

NAP-156-xxx	65H Storage Cabinet with 5 Shelves	35.5x22.5x65
-------------	------------------------------------	--------------

NAP-152-xxx	Storage Cabinet	23.5x22.5x65
-------------	-----------------	--------------

NAP-161-xxx	52"H Storage Cabinet	24x24x52
-------------	----------------------	----------

NAPxxx-212DW	36H Storage Cabinet with Wood Drs	23.5x22.5x65
NAPxxx-212DC	36H Storage Cabinet w/Glass/Wood Drs	23.5x22.5x65
NAPxxx-212DG	36H Storage Cabinet w/Glass/Alum. Drs	23.5x22.5x65

NAP-VO-BLK	Vert. Organizer, Black	12.5x12.5x18.5
------------	------------------------	----------------

HUTCHES

NAPxxx-41	Overhead with Wood/Glass Drs	71x15x36
NAPxxx-42	Overhead with Glass Doors	71x15x36
NAPxxx-44	Overhead with Wood Doors	71x15x36

NAP-HO-BLK	Horizontal Organizer, Black	Fits NAP41, 42, 44	68.7x13x5
------------	-----------------------------	--------------------	-----------

** Tackboard for NAP41/42/44, SON44, KEN42/44

NAPTb-3	Black, 65x17.5
NAPTb-___	Grade A
NAPTb-___	Grade B
NAPTb-___	Grade C
NAPTb-___	Grade R

Overhead Storage

NAP-39-xxx	66x15x36H
NAP-07-xxx	60x15x36H
NAP-34-xxx	48x15x36H
Hutch w/Drs	
NAP-53-xxx	35.5x14x36H
Open Hutch	

Wall-Mount Overhead

NAP-WM36-xxx	36x15x17H	
NAP-WM48-xxx	48x15x17H	
NAPxxx-WM36DG	with Glass Doors	36x15x17H
NAPxxx-WM48DG	with Glass Doors	48x15x17H

Corner Hutch

NAP-84-xxx	42x42x36H
------------	-----------

RECEPTION DESK

NAP-122-xxx	71x35.75/30x41.5H
NAP-123-xxx	Fits NAP122
Glass Floating Top 71x17.5x0.5H	
NAP-125-xxx	42x24x41H
Reception Return Shell	

NAP-121-xxx	48x35.75/30x41.5H
<i>(Not Available in CHY, MAH or URB)</i>	
NAP-126-xxx	Fits NAP-121-ESP
48W Glass Top	48x17.5x0.5H

NAP-20-xxx	24x24x20H
------------	-----------



NAPURB-TYP213G U-Shape with Hutch/File/Storage + Glass Doors 107x112



NAPESP-TYP211 Executive Office



NAPSGW-TYP222 U-Shape 71x112

StepFront pedestals are non-handed

- Front locking
- Finished 4 sides
- Unfinished top



For 36" Deep Desktops, Use:
 NAP-265-xxx Box/Box/File
 NAP-271-xxx False Pedestal
 15.5W x 35.25D x 28H



For 30" Deep Desktops, Use:
 NAP-263-xxx Box/Box/File
 NAP-267-xxx False Pedestal
 15.5W x 30D x 28H



TYPICALS

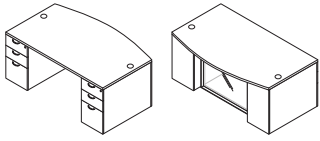

Bow Top Desk 71x40
NAPxxx-TYP201
NAPxxx-TYP201G (Glass Mod. Panel)

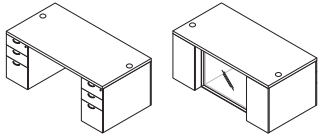

Double Pedestal Desk 71x36
NAPxxx-TYP202
NAPxxx-TYP202G (Glass Mod. Panel)

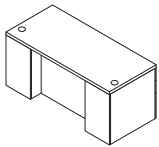

Double Pedestal Desk 66x30
NAPxxx-TYP203

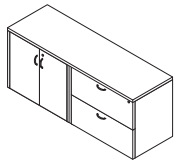

Combo Credenza 71x23
NAPxxx-TYP205

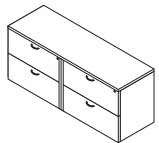

Double Lateral File Credenza 71x23
NAPxxx-TYP206

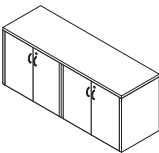

4-Door Storage Credenza 71x23
NAPxxx-TYP207

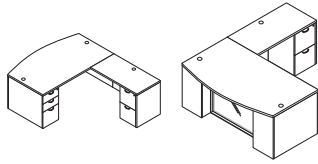

L-Shape w/Bow Top Desk 71x88
NAPxxx-TYP208
NAPxxx-TYP208G (Glass Mod. Panel)

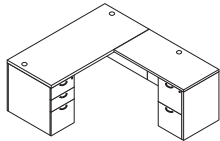

L-Shape Desk 66x78
NAPxxx-TYP209

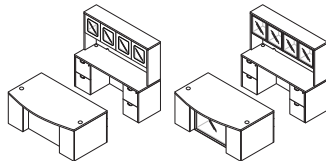

Executive Office
NAPxxx-TYP211
NAPxxx-TYP211G (Glass Mod. Panel)

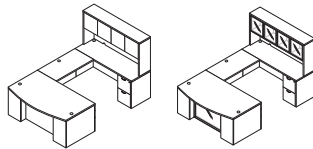

U-Shape with Hutch 71x112
NAPxxx-TYP212
NAPxxx-TYP212G (Glass Mod. Panel)

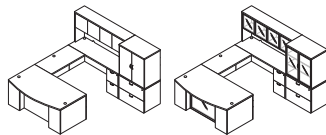

U-Shape w/Hutch + File Storage 107x 112
NAPxxx-TYP213
NAPxxx-TYP213G (Glass Mod. Panel)

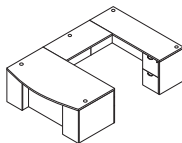

U-Shape 71x112
NAPxxx-TYP222

ITEMS

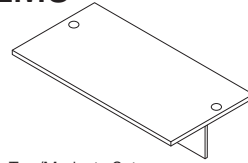

Desk Top/Modesty Set
NAP-201-xxx 71x36x29

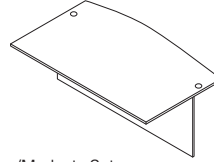

Desk Top/Modesty Set
NAP-289-xxx 71x40x29

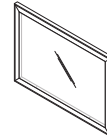

Glass Modesty Panel for NAP201 & 289 Desk
NAP-200 40x28x1

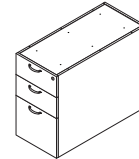

36" Deep Desk Pedestal I Box/Box/File
NAP-265-xxx 15.5x35.3x28

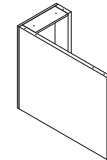

36" Deep False Pedestal
NAP-271-xxx 15.25x35.25x28

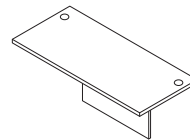

Desk Top/Modesty Set
NAP-202-xxx 66x30x29

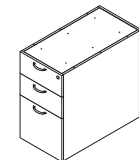

30" Deep Pedestal Box/Box/File
NAP-263-xxx 15.25x29.75x28
 Ships Assembled

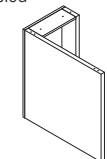

30" Deep False Pedestal
NAP-267-xxx 15.25x29.75x28

Available Finishes



SGW
Slate Grey

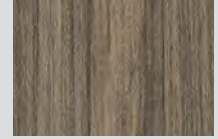

URB
Urban Walnut

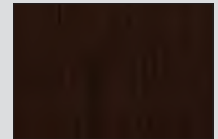

ESP
Espresso

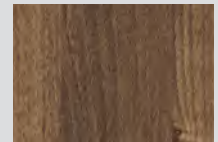

PCW
Park City
NJ Only



CHY
Cherry
NJ Only



MAH
Mahogany
NJ Only



LODESP-TYP321 includes LOD-101/43/42 & (4) LOD-76 Peds
Price does not include File & Open Hutch
3680 Chair



L-Shape + Wood Door Hutch and (2) Peds 71x78
LODESP-TYP328
67-E36N61R5 Chair



U-Shape with Hutch includes LOD-01/70/43/41
and (2) LOD-76 Pedestals 71x103



Double Pedestal
Credenza 71x20
LODURB-TYP5

Grommet Charger
Includes:
(2) USB Type-C
& (1) A/C ports

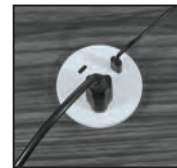

Fits any Lodi
grommet hole.

PM7102W



PM7102B

Available
Finish



SGW
Slate Grey

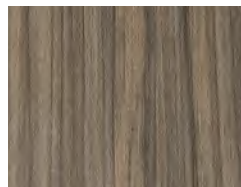

URB
Urban Walnut



ESP
Espresso



CHY
Cherry

NJ stock = all colors
TX stock = URB & ESP
CA = no stock

TYPICALS

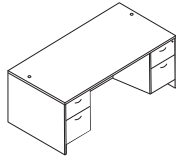

Double Pedestal Desk 71x30
LODxxx-TYP301

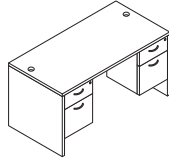

Double Pedestal Desk 60x30
LODxxx-TYP4

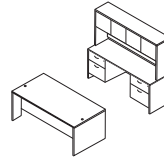

Executive Office
LODxxx-TYP311

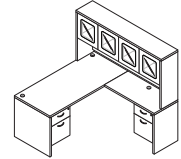

L-Shape with Hutch 66x72
LODxxx-TYP31

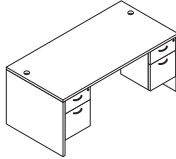

Double Pedestal Desk 71x35
LODxxx-TYP2

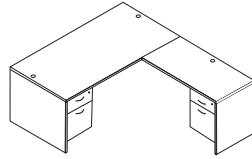

L-Shape Desk 71x78
LODxxx-TYP308

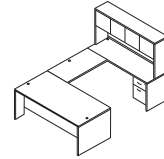

U-Shape with Hutch 71x98
LODxxx-TYP312

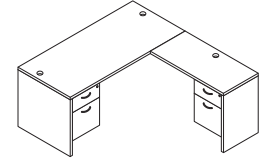

L-Shape 66x72
LODxxx-TYP32

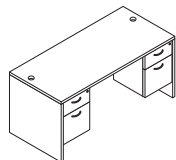

Double Pedestal Desk 66x30
LODxxx-TYP3

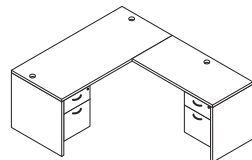

L-Shape Desk 66x78
LODxxx-TYP9

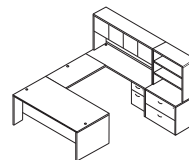

U-Shape w/Hutch + Storage 101x98
LODxxx-TYP313

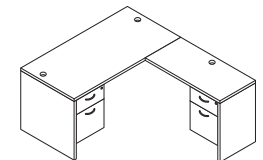

L-Shape 60x72
LODxxx-TYP34

ITEMS

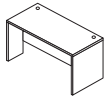

Desk Shell

- LOD-01 71x35x29H
- LOD-101 71x30x29H
- LOD-02 66x30x29H
- LOD-03 60x30x29H
- LOD-22 45x24x29H

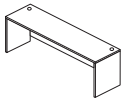

Credenza Shell

- LOD-43 71x20x29H

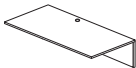

Bridge

- LOD-70 48x24x29H

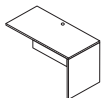

Returns

- LOD-45 48x24x29H
- LOD-46 42x20x29H



Pedestals

- LOD-76 Box/File, Hanging



Hutches 71"W

- LODxxx-41 Wood Glass Doors
- LODxxx-42 Glass/Alum. Doors
- LODxxx-44 Wood Doors

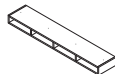

Horizontal Organizer - 71" Hutches

- NAP-H0-BLK 68.7x13x5H

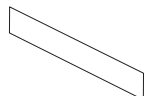

Tackboard for NAP42/44, SON44, KEN42/44

- NAPTb-3 Black, 65x17.5H
- NAPTb____ Grade A
- NAPTb____ Grade B
- NAPTb____ Grade C
- NAPTb____ Grade R

Storage & Filing

- LOD-12 2-Drwr Lateral File 30x20x29H



- LOD-13 2-Dr Storage Cabinet 30x20x29H



- LOD-55 2-Shelf Bookcase 30x12x29H

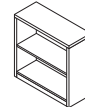

- LOD-53 Open Hutch 30x12x36H



Accessories

- NAP-14 Keyboard Tray
- NAP-15 Center Drawer
- NAP-VO-BLK Vert. Organizer

Power/USB Charger, Clamp Mount

- PM5311B Black
- PM5311W White

Power/USB Charger, Undersurface Mount

- PM8311B Black
- PM8311W White

Metallic Grommets

- NAP-GM 5-pack

OSP ASCEND II®

CASEGOODS



Supporting active working for a healthier lifestyle.

Our bodies were born to move. Alternate between sitting and standing throughout the day to avoid sedentary effects and to promote proper alignment of your shoulders, neck and back.

72x72 Electric Height-Adjustable L-Shape A337272WHU + A2MOD72-URB Modesty Panel
Price does not include Napa credenza/pedestal/hutch, monitor arm or desktop power module

Features

- Dual & triple-motor electric height-adjustable bases
- C-Leg base design
- 4 programmable memory presents
- One-Touch memory capability
- Hi & Low lockout (any position)
- Anti-collision with adjustable settings
- 32mm/second (110 lbs. load or less)
- Quiet operation (under 50 dB)
- Overload protection
- BIFMA tested, UL certified components

3-Stage Bases

Height Range: 24.5" to 50"
Weight Capacity 2-Leg: 220 lbs.
Weight Capacity 3-Leg: 300 lbs.

2-Stage Bases

Height Range: 27" to 44.5"
Weight Capacity: 180 lbs.

HEIGHT-ADJUST BASES

A2EB322-xx
3-Stage/2-Leg

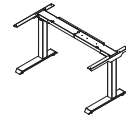

A2EB333-xx
3-Stage/3-Leg

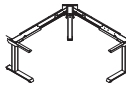

A2FEET30-x
Feet for 30"D Tops
(set of 2)



A2EB222-x
2-Stage/2-Leg

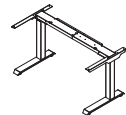

TOPS



842T26-x 71x24
842T25-x 60x24
842T24-x 48x24
842T3060-x 60x24

MODESTY PANELS



A2MOD60-xxx 5' Panel
56.75 x 3.5 x 13.75H
A2MOD72-xxx 6' Panel
69 x 3.5 x 13.75H

Base Colors



Top and Modesty Panel Colors



Top-Only Colors



TYPICALS

3-Stage / 2-Motor / 2-Leg Height Adjust Desk/Table with A2EB322-x Base 25.5" to 51"H

Size	TYPICAL# + Base Color + Top Color	List	TOP#
48x24	A322448 __ (base) __ (top)		842T24-x
60x24	A322460 __ (base) __ (top)		842T25-x
72x24	A322472 __ (base) __ (top)		842T26-x
60x30	A323060 __ (base) __ (top)		842T3060-x



Order Example:
A337272SVS

Base:
Silver (SV)

Top:
Slate Grey (S)

3-Stage / 3-Motor / 3-Leg Height Adjust L-Shape with A2EB333-x Base 25.5" to 51"H

Size	TYPICAL# + Base Color + Top Color	List	TOP#
60x72	A336072 __ (base) __ (tops)		842T25-x 842T24-x
72x72	A337272 __ (base) __ (tops)		842T26-x 842T24-x
60x78	A336078 __ (base) __ (tops)		842T3060-x 842T24-x



72x72 Electric Height-Adjustable L-Shape A337272SVS
Price does not include Napa casegoods, monitor arm, seating or metal file

OSP ASCEND II®

CASEGOODS



Personal Storage

Drawer with Lock + Shelf Area
A2PS
 Matching White (WH), Silver (SV) or Black (B)



TYPICALS

2-Stage / 2-Motor / 2-Leg Height Adjust Desk/Table with A2EB222-x Base 27" to 44.5"H

Size	TYPICAL# + Base Color + Top Color	List	TOP#
48x24	A222448 __ (base) _ (top)		842T24-x
60x24	A222460 __ (base) _ (top)		842T25-x
72x24	A222472 __ (base) _ (top)		842T26-x
60x30	A223060 __ (base) _ (top)		842T3060-x



Modesty Panels

13.75" high
 Matches Top Laminates
A2MOD60-xxx 5' Panel
A2MOD72-xxx 6' Panel
In Stock in URB (shown), SGW, ESP & WHT

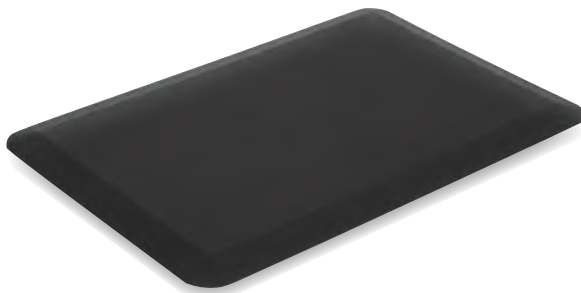

Standing Mat

30" x 20" Standing Mat
AM2030B \$90

- Dense Memory Foam, 7/8" Thick
- Non-slip
- Puncture Resistant
- Non-Toxic, VOC-Free
- Relieves Stress on Feet and Joints



OSP ASCEND II® Monitor Arms

- Gas-Assist easy-adjust arms with 3-point adjustment
- Dual USB Ports and cable management
- Grommet and edge mount hardware included
- Supports 17"-30" monitors with 20 lbs. weight capacity

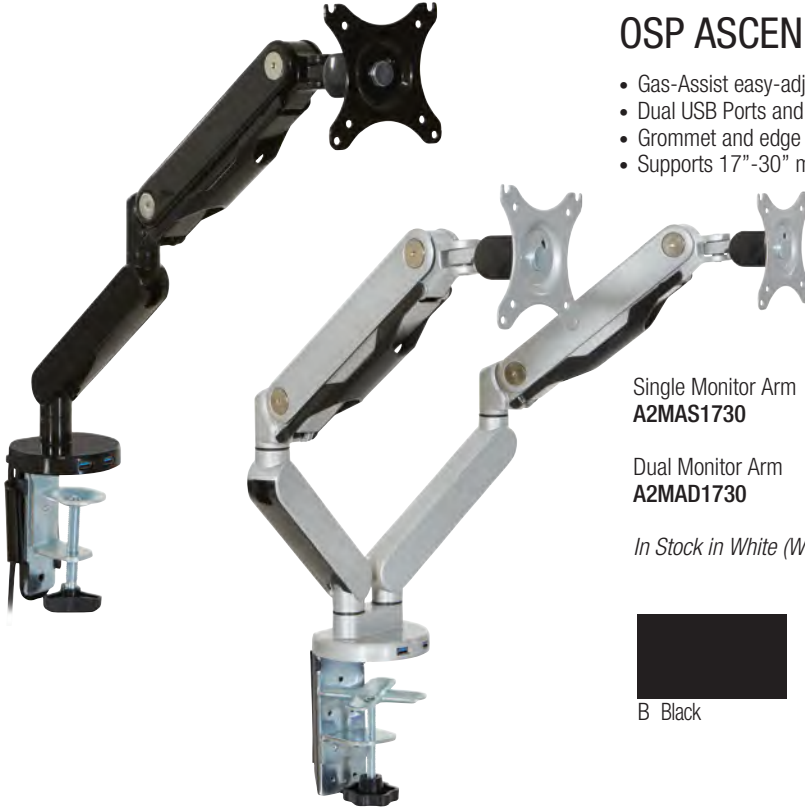

Single Monitor Arm
A2MAS1730

Dual Monitor Arm
A2MAD1730

In Stock in White (WH), Silver (SV) and Black (B)



B Black

SV Silver

WH White

Desk Power Chargers

Convenience at your fingertips!

- (3) A/C Power outlets
 - (1) USB Type C & (1) USB Type A ports
- In Stock in White (WH) and Black (B)*

Edge Mount
PM5311



Undersurface Mount
PM8311



48x24 Electric Height-Adjustable Desk
White/Urban Walnut
A322448WHU

Also shown:

NAP-43-URB Credenza
NAP-69-URB MultiFile

Dual Monitor Arm
with Dual USB Ports
A2MAD1730-WH

SPACE® SEATING
Drafting Stool
with Custom Fabric
Icon Navy, -225
13-37N20D-225



PHAT Pneumatic Height Adjustable Tables

CASEGOODS



Pneumatic Height Adjustable Table with Black Locking Casters 60 x 24 PHAT2460U3

Features

- Mobile height-adjustable desk/table
- Large dual-wheel, locking casters
- Adjusts 30.25" to 43.25" high
- Dual-pneumatic lifting
- Synchronized driveshaft
- Optional modesty panels for 5' & 6' tables
- Fully enclosed center channel conceals components
- Black EPD finish channel, top supports and inner sleeves
- Legs in Black, White or Titanium

Standing Mat

30" x 20" Standing Mat

AM2030B \$90

- Dense Memory Foam, 7/8" Thick
- Non-slip
- Puncture Resistant
- Non-Toxic, VOC-Free
- Relieves Stress on Feet and Joints

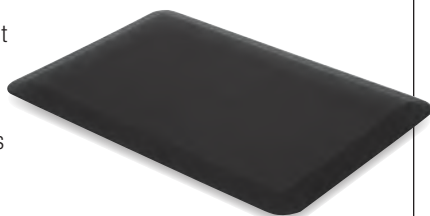

HEIGHT-ADJUST BASES

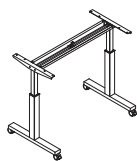

HB6024-x 4' Base
HB6025-x 5' Base
HB6026-x 6' Base

TOPS



842T26-x 71x24
842T25-x 60x24
842T24-x 48x24
842T3060-x 60x30

MODESTY PANELS

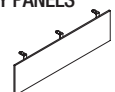

A2MOD60-xxx 5' Panel
56.75 x 3.5 x 13.75H
A2MOD72-xxx 6' Panel
69 x 3.5 x 13.75H

Base Colors

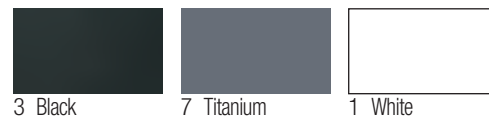

3 Black 7 Titanium 1 White

Top and Modesty Panel Colors



S Slate Grey E Espresso
W White U Urban Walnut

Top-Only Colors

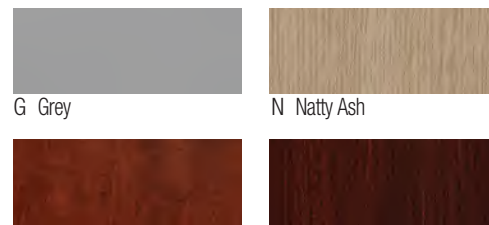

G Grey N Natty Ash
C Cherry M Mahogany



Has achieved GREENGUARD certification

TYPICALS



OSP AXIOS® Monitor Arms



Double Arms,
Charcoal only
SPX2720DMA



Single Arm,
Charcoal only
SPX3020SMA

60x24 White/Black PHAT2460W3 + A2MOD60-WHT Modesty Panel
Price does not include Napa credenza, hutch and pedestals shown.

Pneumatic Height-Adjustable Desk/Tables

Size	TYPICAL# + Top Color + Base Color	List	TOP#
48x24	PHAT2448 _ (top) _ (base)		842T24-x, HB6024-x
60x24	PHAT2460 _ (top) _ (base)		842T25-x, HB6025-x
72x24	PHAT2472 _ (top) _ (base)		842T26-x, HB6026-x

Order Example:

PHAT2472U1

Top:
Urban Walnut (U)

Base:
White (1)

72x24 Urban Walnut/White
PHAT2472U1 + A2MOD72-
URB Modesty Panel





SON-TYP13 U w/Hutch + Storage & (2) Full Pedestals 108x107 | 5500® Chair

Sonoma

presents the beauty of real wood with hand-selected hardwood veneers and multi-step, full-fill Cherry finish that enhances the depth and clarity of the wood. Solid wood edges are rounded and complemented with compound 8-way radius corners for smooth, elegance and classic style.

Features

- Book-matched hardwood veneers
- Solid wood edges
- 2" thick Table tops with cylinder bases
- 1-1/8" thick worksurfaces
- Matching drawer interiors
- All-metal, pre-installed filing hardware
- Full-extension, steel ball-bearing slides



SON-TYP8 L-Shape w/Bow Top Desk 72x87



SON-12 File & SON-55 Hutch | MST51 Chair w/Custom Fabric

SONOMA
TYPICALS

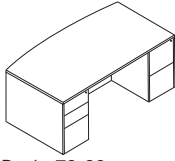

Bow Top Desk 72x39
SON-TYP1

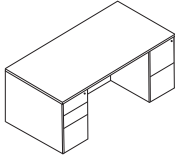

Double Pedestal Desk 72x36
SON-TYP2

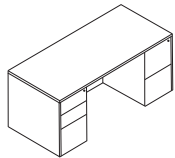

Double Pedestal Desk 66x30
SON-TYP3

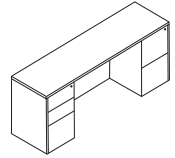

Kneespace Credenza 72x20
SON-TYP5

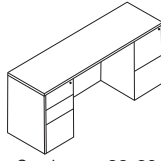

Kneespace Credenza 66x20
SON-TYP6

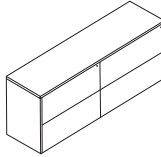

Double Lateral File Credenza 72x20
SON-TYP7

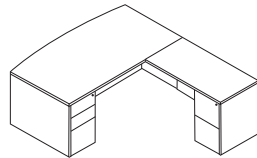

L Shape w/Bow Top Desk 72x87
SON-TYP8

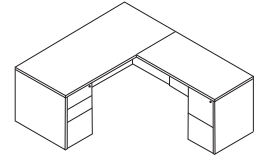

L Shape 66x78
SON-TYP9

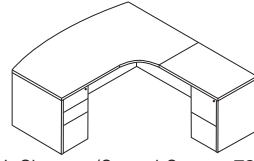

Left L Shape w/Curved Corner 72x82
SON-TYP10R

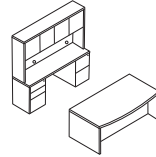

Executive Office
SON-TYP11

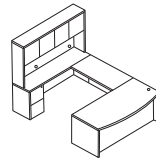

U Shape with Hutch 72x107
SON-TYP12

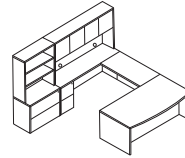

U w/Hutch + Storage 108x107
SON-TYP13

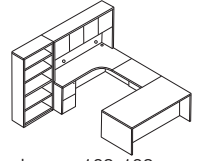

Left U Bookcase 108x108
SON-TYP14L

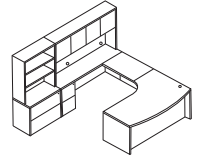

Left U w/Corner + Storage 108x102
SON-TYP15L

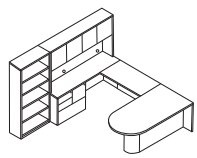

U w/Bullet + Bookcase 108x104
SON-TYP16

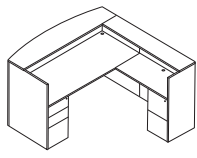

Reception Station 72x72x43
SON-TYP19

4-Drawer Lateral File
37x20x56H
SON-109



2-Door Storage
Cabinet Wardrobe
37x19x70H
SON-51
Storage/Lateral File
37x19x70H
SON-52



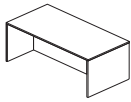

Desk Shell

- SON-01 71x36x29H
- SON-02 66x30x29H

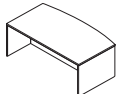

Bow Front Desk Shell

- SON-89 72x39x29H

Bow Front Corner Desks

SON-87L

Left Corner



SON-87R

Right Corner



72x30/48x29H

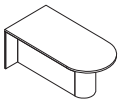

Bullet Desk

- SON47 72x36x29H

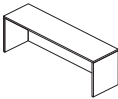

Credenzas

- SON-43 72x20x29H
- SON-11 66x20x29H

Corner Credenzas

SON-82L

Left Corner



SON-82R

Right Corner



72x36/20x29H

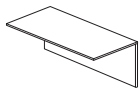

Bridges

- SON-70 48x24x29H
- SON-98 42x24x29H
- SON-93 36x24x29H

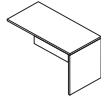

Returns

- SON-45 48x24x29H
- SON-96 48x24x29H
- SON-92 36x24x29H



Desk Pedestals 24"D

- SON-65 Box/Box/File
- SON-74 File/File



Returns/Credenza Pedestals 18"D

- SON-66 Box/Box/File
- SON-75 File/File
- SON-68 Lateral File, 35"W
- SON-69 MultiFile, 32"W

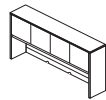

Hutch 72"D

- SON-44 Wood Doors 72x14x42H

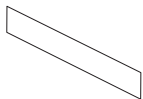

Tackboard - 72" Hutch

- NAPT B-3 Black, 65x17.5H
- NAPT B-A Grade A
- NAPT B-B Grade B
- NAPT B-C Grade C
- NAPT B-R Grade R

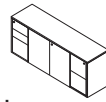

Storage Credenzas

- SON-10 72x20x29H

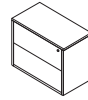

Lateral Files

- SON-12 2-Drawer
- SON-109 4-Drawer

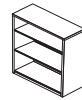

Bookcases

- SON-55 Bkcase Open Shlf 36x14x42H
- SON-56 5-Shlf Bkcase 36x14x70H

- SON-13 2-Door Storage 37x20x29H



- SON-50 2-Door Storage 37x20x29H



- SON-51 2-Door Wardrobe 37x19x70H



- SON-52 Storage/Lateral 37x19x70H

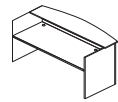

Reception

- SON-122 Reception Desk 72x30/36x43H
- NAP-123 Optional Glass Floating Top
- SON-125 Reception Return 42x20x42H
- SON-124 Counter Top For SON-125 60x12.5
- SON-19 Coffee Table 48x24x16H
- SON-20 End Table 24x24x20H

Accessories

- SON-14 Keyboard Tray
- SON-15 Center Drawer

Locks

- LK1-GC Lock Core Replacements w/Keys
- KC-GC Change Key
- KM-GC Master Key



SON-TYP3 Double Ped Desk 66x30



SON79CHY-3 \$600
Sonoma Upholstered Back Guest Chair
Black Fabric
23.5 x 24.5 x 33.25H



SON77CHY-3 \$570
Sonoma Wood Back Guest Chair
Black Fabric
23.5 x 24.5 x 33.25H



Executive Office with Glass Door Hutch TOWCHY-TYP11

shown with TWN300L-3 Leather Chair

Townsend

blends the heritage of traditional designs with modern office function in select hardwood veneers and Royal Cherry finish. Unique veneer design tops and 3"-thick shaped edge profile marks the craftsmanship and classic style.

Integrated felt-lined center drawer on all desktops.

Felt-lined box drawers on pedestals.



Features

- Hardwood veneer on all surfaces
- Reverse-diamond match veneer tops
- 3" thick, traditional shaped edges
- Solid wood picture-frame molding
- Solid wood base trim
- Decorative pilasters
- Royal Cherry finish with durable satin polyurethane topcoat
- Matching drawer interiors
- Antique brass drawer/door pulls
- Keyboard Tray included with all bridges, returns and double pedestal credenzas
- Wire management on tops and modesty panels of returns, bridge and credenzas
- Full-extension file drawers with legal/letter filing and steel ball-bearing suspensions
- Single-key locking with replaceable lock cores



TOWCHY-TYP8R Right Return L-Shape 72x84

Price does not include TOW Storage Cabinet & Hutch | TEX228-JT4 Chair

TYPICALS

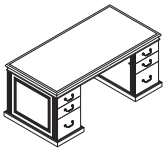

Double Pedestal Desk
TOWCHY-TYP2 72x36x30H
 TOW-01, 65L, 65R
TOWCHY-TYP3 66x30x30H
 TOW-02, 63L, 63R
TOWCHY-TYP4 60x30x30H
 TOW-03, 63L, 63R

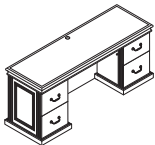

Double Pedestal Credenza
TOWCHY-TYP5 72x24x30H
 TOW-43, 75L, 75R

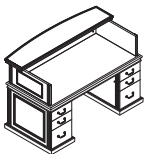

Reception Desk
TOWCHY-TYP119 72x37x45.5H
 TOW-01, 65L, 65R, 126

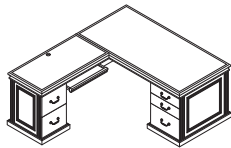

Left L-Shape Desk
TOWCHY-TYP8L 72x84
 TOW-01R, 64R, 45L, 75L
TOWCHY-TYP9L 66x78
 TOW-02R, 62R, 45L, 75L

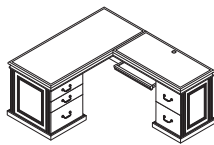

Right L-Shape Desk
TOWCHY-TYP8R 72x84
 TOW-01L, 64L, 45R, 75R
TOWCHY-TYP9R 66x78
 TOW-02L, 62L, 45R, 75R

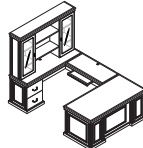

Left + U-Shape Desks with Hutch
TOWCHY-TYP12L 72x108x75H
 without Hutch
TOWCHY-TYP22L 72x108x30H

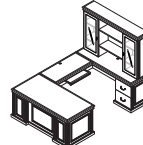

Right + U-Shape Desks with Hutch
TOWCHY-TYP12R 72x108x75H
 without Hutch
TOWCHY-TYP22R 72x108x30H

WALL UNITS

90x14x72H

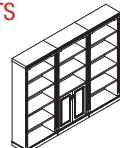

TOWCHY-TYPWALL
 TOW-113, 156 (2 qty.)

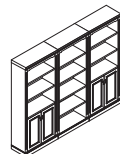

TOWCHY-TYPWALL 2
 TOW-156, 113 (2 qty.)

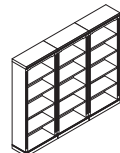

TOWCHY-TYPWALL 3
 TOW-156 (3 qty.)

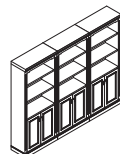

TOWCHY-TYPWALL 4
 TOW-113 (3 qty.)

INDIVIDUAL WALL-UNIT ITEMS

TOW-113-CHY Bookcase with Doors
 TOW-156-CHY Bookcase
 Flat sides for flush, side-by-side application

ITEMS

HUTCHES

TOW-44-CHY

Wood Doors
72x14x45H

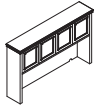

TOWCHY-84

Glass Doors
72x14x45H

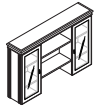

LATERAL FILES

TOW-12-CHY

2-Drawer
36x20x30H



TOW-109-CHY

4-Drawer
36x20x54H



6-Shelf Bookcase

TOW-56-CHY

32x14x75H

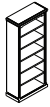

2-Door Wardrobe

TOW-151-CHY

24x24x75H



STORAGE

TOW-13-CHY

2-Door Cabinet
36x20x30H

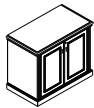

TOW-53-CHY

Open Hutch
36x20x45H



TOW-50-CHY

4-Door Credenza
72x20x30H

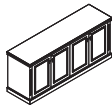

TOWCHY-TYP9R Right Return L-Shape 66x78

| 3121-K024 Ergonomic Chair



TOWCHY-TYP12R Right U-Shape with Glass Door Hutch

| TWN300L-3 Chair



TOW-61-CHY- 10' Conference Table 120x48

| TEX280-3 Chair

CONFERENCE Tuxedo

TABLES



TUXSGW-60 Slate Grey Rectangular Table 96x48 | 920351C-R105 Chair

Features

- Build tables to length
- 48" Tops/Bases stocked separate; mix/match colors
- Bases feature 3-way wire management



- 48" Tops include charging module with dual USB/ & dual A/C ports.



SGW
Slate Grey



DKR
DarkRoast



PCW
Park City



WHT
White



TUXWHTDKR-60 White Top/Dark Roast Bases Table 96x48 | 95673-3M Chair



TUXSGW-61 Slate Grey Rectangular Table 120x48
Consists of: TUXSGW-59 48" Square Top/Base (\$1,780 ea) x 2 qty
+ TUX-59E-SGW 24"x48" Top/Base (\$890 ea) x 1 qty.

For TUXxxxxx-61 in 2-Color Combination, order TUX-59E-xxx in each color.



4-Door 72" Conference Credenza
TUXSGW-TYP207
TUXWHTSGW-TYP207

Expandable Racetrack



EXPESP-TYP12R 12'x4' Espresso Table

| FL1327C-U28 Chair

Features

- 4' & 5' modular components
- 1.5' thick tops & 1" thick legs
- Silver grommets included in each top
- Dual-stretcher design conceals wires
- Optional HDMI/data/phone/USB power module fits grommet cutout (EXPPOW1)



EXPSGW-TYP15R
15'x4' Slate Grey Table

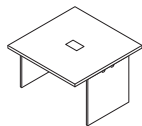

Interior Modules
EXP-228-xxx
47.2"W
EXP-229-xxx
59.1"W

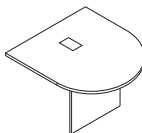

Bullet Ends
EXP-230-xxx
47.2"W
EXP-231-xxx
59.1"W

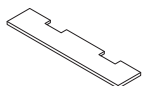

EXP-232-xxx
Replacement Stretcher
for 8' Table only
EXP-233-xxx
Replacement Stretcher
for 10' Table only

Build tables to any length!

Size	TYPICAL#	List	Consists of:
12'	EXPxxx-TYP12R		(1) EXP-228, (2) EXP-230
14'	EXPxxx-TYP14R		(1) EXP-228, (2) EXP-231
16'	EXPxxx-TYP16R		(2) EXP-228, (2) EXP-230
20'	EXPxxx-TYP20R		(2) EXP-229, (2) EXP-231
24'	EXPxxx-TYP24R		(1) EXP-228, (2) EXP-229, (2) EXP-231

8' & 10' Tables (only) require replacement stretchers:

8'	EXPxxx-TYP8R	(2) EXP-230, (1) EXP-232
10'	EXPxxx-TYP10R	(2) EXP-231, (1) EXP-233



Power/Data/Phone/USB/HDMI Unit
EXP-POW1 12.6 x 4.1 x 4H



CHY
Chery



ESP
Espresso



MAH
Mahogany



SGW
Slate Grey

CONFERENCE

Napa Conference | Breakroom

TABLES



NAPESP-37 Napa Espresso 10' Racetrack Table 120x48 | 920350C-R107 Chair



NAPNAS-TYP20 3-Pc. Conference Group \$3,245 | 5540 Chair \$695

Racetrack Tables

Model	Size	List
NAP-35	72x36	
NAP-36	96x42	
NAP-37	120x48	
NAP-38	144x48	

NAP-37 and NAP-38 not available in WHT

Round Tables

Model	Size	List
NAP-27	42" Dia.	
NAP-23	47" Dia.	



NAPESP-132 42" High Breakroom Table | NAPESP-32 29" High Breakroom Table
88657C2-R106 Visitor's Chair | 8455C2-R105

Breakroom Tables

Model	Size	List
29" High		
NAPxxx-32	30" Dia.	
NAPxxx-33	36" Dia.	

42" High		
NAPxxx-132	30" Dia.	
NAPxxx-133	36" Dia.	

Available Finishes



Sonoma Wood Veneer



SON62 Sonoma 12'x4' Racetrack Table | ECH38665A-EC3 Chair

Features

- Select hardwood veneers, book-matched
- Solid wood, radius edges
- 2- thick tops
- Multistep, full-fill Cherry finish with polyurethane topcoat
- Racetrack tables with half-cylinder bases
- Round tables with full-cylinder bases
- Matching wood chairs



SON-50
72x20 Credenza

Racetrack Tables

Model	Size	List
SON35	72x36	
SON60	96x42	
SON61	120x48	
SON62	144x48	
SON63	168x48	

Round Tables

Model	Size	List
SON58	42" Dia.	
SON59	48" Dia.	

Sonoma Presentation Board
SON-100 48x48



SON60 Sonoma 96x42 Table | 5540 Chair

CONFERENCE

Townsend Wood Veneer

TABLES



TOW-61-CHY Townsend 10' Rectangular Leg-Base Table 120x48

| TEX280-3 Chair

Features

- Reverse-diamond match wood veneers
- Royal Cherry finish, polyurethane topcoat
- 3"-thick, shaped edges
- Leg bases with picture-frame molding
- Queen Anne style bases
- Traditional seating with matching finish



TOW-50-CHY
72x20 Credenza

Leg Base Tables

Model	Size	List
TOW-59-CHY	48" Dia.	
TOW-35-CHY	72x36	
TOW-60-CHY	96x48	
TOW-61-CHY	120x48	
TOW-62-CHY	144x48	

Queen Anne Base Tables

Model	Size	List
TOW-59Q-CHY	48" Dia.	
TOW-35Q-CHY	72x36	
TOW-60Q-CHY	96x48	
TOW-61Q-CHY	120x48	
TOW-62Q-CHY	144x48	



TOW-59Q-CHY 48" Round Table with Queen Anne Base

| TWN300L-3 Chair



Bases

Model	Size	List
SFT4530-SV	Silver	
SFT4530-B	Black	

Tops

Model	Size	List
PWS4824	48x24	
PWS4830	48x30	
PWS6024	60x24	
PWS6030	60x30	

Features

- T-Leg design allows users on both sides of table
- Supports 24"D & 30"D tops
- Base adjusts 43"-55" to support various top widths
- Black or Silver finish
- Stylish foot and column design
- Single-lever actuator
- Locking casters



Available Finishes



SGW
Slate
Grey



URB
Urban
Walnut



WHT
White



NAS
Natty
Ash



PCW
Park
City



ESP
Espresso

NJ Only



Mobile Magnetic Glassboard

MMGB4072-B
40W x 23.5D x 72H

Features

- Tempered glass white/erase board
- Markers, eraser and holder included
- Magnetic surface with magnets included
- Tackable grey PET backside
- Black edges, feet & locking casters



84225BN and 84224BN Nesting Training Tables | EM51022N-K041 Chair

Features

- Allows quick, one-person setup and change of table configurations to address any event.
- One-touch flip mechanism can be activated from either end of the table.
- Top locks into position when upright or horizontal.
- All-steel frames and integrated modesty panel
- Oversize locking casters for use on any floors.
- Tops built with commercial-grade, thermally fused laminate and impact-resistant PVC edges
- Comprehensive selection of folding/nesting chairs available in matching finish



84225TG
60x24
Titanium Base
and Grey Top

84220-30
Armless Folding/Nesting Chair
(2-pack)



Tables fold and nest for space-saving convenience.

84225BN
60x24 Black Base
and Natty Ash Top

EM51022N
in Custom Fabric



24" Deep Tables

Size	TYPICAL# + Base Color + Top Color	List
48x24	84224 _ (base) _ (top) <i>Consists of: 842FM4-x + 842T24-x</i>	
60x24	84225 _ (base) _ (top) <i>Consists of: 842FM5-x + 842T25-x</i>	
72x24	84226 _ (base) _ (top) <i>Consists of: 842FM6-x + 842T26-x</i>	

Frame Only 24"D Tops	List
842FM4-x 4' Base	
842FM5-x 5' Base	
842FM6-x 6' Base	



Top Colors

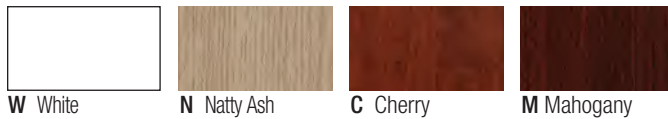

Base Colors



Order Example:

8 4 2 2 4 B S

Base: ↓
Black (B)

Top: ↓
Slate Grey (S)

18" Deep Tables

Size	TYPICAL# + Base Color + Top Color	List
48x24	842184 _ (base) _ (top) <i>Consists of: 842FM418-x + 842T1848-x</i>	
60x24	842185 _ (base) _ (top) <i>Consists of: 842FM518-x + 842T1860-x</i>	
72x24	842186 _ (base) _ (top) <i>Consists of: 842FM618-x + 842T1872-x</i>	

Frame Only 18"D Tops	List
842FM418-x 4' Base	
842FM518-x 5' Base	
842FM618-x 6' Base	

Top Colors



Base Colors



Bases include Ganging Clips & Thumbscrews for easily connecting and disconnecting tables. Tops include pre-installed metal inserts (underside). Extra ganging kit 842GK1.

TRAINING Metal Legs / Tables

TABLES



LTCB6024N
60x24 Table - Black/Natty Ash
Consists of: LTC-B 2 qty, LSB5-B,
PWS6024-NAS



LTGS6630S
66x30 Table - Silver/Slate Grey
Consists of:
LTG-SV 2 qty.,
LSB5-B, PWS6630-SGW

T-Arc Legs



LTC-B Casters, Black
LTC-SV Casters, Silver
LTG-B Glides, Black
LTG-SV Glides, Silver
(2-pack)



Post Legs 30" D Tops

LPGS6030W
60x30 Table
Silver/White
Consists of:
LP30G-SV, 2 qty. LSB5-B,
PWS6030-WHT



Post Legs 24" D Tops

LPGS4830S
48x30 Table
Silver/Slate Grey
Consists of:
LP30G-SV, LSB4-B,
PWS4830-SGW

LPCB4824N
48x24 Table - Black/Natty Ash
Consists of:
LP24C-B, PWS4824-NAS

LPCB3624U
36x24 Table
Black/Urban Walnut
Consists of:
LP24C-B, PWS3624-URB

Post Legs 30" Tops



LP30C-B Casters, Black
LP30C-SV Casters, Silver
LP30G-B Glides, Black
LP30G-SV Glides, Silver
(4-pack)

Post Legs 24" Tops



LP24C-B Casters, Black
LP24C-SV Casters, Silver
LP24G-B Glides, Black
LP24G-SV Glides, Silver
(4-pack)

Top Colors



Tops 24" D

- PWS7224** 72"x 24"
- PWS6624** 66"x 24"
- PWS6024** 60"x 24"
- PWS4824** 48"x 24"
- PWS4224** 42"x 24"
- PWS3624** 36"x 24"
- PWS3024** 30"x 24"

Tops 30" D

- PWS7230** 72"x 30"
- PWS6630** 66"x 30"
- PWS6030** 60"x 30"
- PWS4830** 48"x 30"

Support Bars

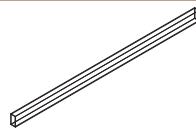

LSB4-B For 4' Top
LSB5-B For 5' Top
LSB6-B For 6' Top

*Full presentation on pages 12-13

Tuxedo









-  DKR
Dark Roast
-  SGW
Slate Grey
-  PCW
Park City

3-Shelf Bookcase 36x16x42H
TUX-55-xxx

5-Shelf Bookcase 36x16x72H
TUX-56-xxx

Napa



-  SGW
Slate Grey
-  URB
Urban Walnut
-  WHT
White
-  NAS
Natty Ash
-  PCW
Park City
-  ESP
Espresso
-  CHY
Cherry
-  MAH
Mahogany

3-Shelf Bookcase 35.5x14x42H
NAP-55-xxx

5-Shelf Bookcase 35.5x14x65H
NAP-56-xxx



36"H Quarter Round
Open Hutch
15x15x36H
NAP-253-xxx

29"H Quarter
Round Bkcase
24x24x29H
NAP-254-xxx

NAP-253 & NAP-254 not available in White

Features

- Matches Napa & Lodi laminates
- Shelf weight capacity: 100 lbs.
- Finished 3/4"-thick back panel
- Heavy-duty 1"-thick shelves
- Smooth, impact-resistant PVC edges
- Adjustable leg levelers
- Assembly required



LBC361230-URB

LBC361248-MAH

LBC361272-ESP

LBC361284-CHY



CHY Cherry

ESP Espresso

MAH Mahogany

URB Urban Walnut

SGW Slate Grey

WHT White
30H & 60H only

Laminate Bookcases

Model #	List	Description
LBC361230-xxx		36x12x30H 2-Shelf
LBC361248-xxx		36x12x48H 3-Shelf
LBC361260-xxx		36x12x60H 4-Shelf
LBC361272-xxx		36x12x72H 5-Shelf
LBC361284-xxx		36x12x84H 6-Shelf



Extra 1" Thick Shelf
for 36Wx12D
Laminate Bookcase
LBCSHF-xxx



4-Shelf Laminate Bookcase LBC361260-ESP List:

STORAGE Napa

STORAGE & FILING

Features

- Scratch-resistant, textured thermally fused laminate surfaces with particleboard core
- Impact-resistant 3mm PVC edges
- Commercial grade
- CARB & TSCA compliant
- Black metal pulls;
- optional metallic finish pulls
- Metallic finish pulls standard on Espresso & Park City
- Drawer/door pull options on page 38



36"H Storage Cabinet 35.5x22.5x36H

Model #	List	Description
NAPxxx-212DW		w/Wood Doors
NAPxxx-212DG		Glass/Alum. Doors
NAPxxx-212DC		w/Glass/Wood Doors
<i>**Not available in WHT</i>		
NAP-212H-xxx		without Doors
<i>NAP-212s can be used freestanding or on top of file/cabinet.</i>		

NAPSGW-212DG with NAP-12-SGW
List:



65"H Storage Cabinet
23.5x22.5x65H
NAP-152-xxx
Ships Assembled



52"H Storage Cabinet
24x24x52H
NAP-161-xxx
Ships Assembled
****Available in SGW, URB & WHT only**



65"H Two-Door Storage Cabinet w/5 Shelves
35.5x22.5x65H
NAP-156-xxx



Four-Drawer Lateral File
36x22.5x53H
NAP-109-xxx
Ships Assembled
****Not available in WHT**



Two-Drawer Lateral File
35.5x22.25x29H
NAP-12-xxx
Ships Assembled



Two-Door Storage Cabinet
35.5x22.25x29H
NAP-13-xxx

NAPURB-TYP205



Credenzas 71x23

Model #	List	Description
NAPxxx-TYP205		Combo Credenza
NAPxxx-TYP206		Double Lateral File
NAPxxx-TYP207		4-Door Storage



NAPPCW-TYP206



Napa Hutches & Wall-Mounts



NAPWHT-TYP13 U-Shape with Hutch + Storage



Hutches 71x15x36H

Model #	List	Description
NAPxxx-41		Overhead with Wood/Glass Doors
<i>**Not available in WHT</i>		
NAPxxx-42		Overhead Storage with Glass Doors
NAPxxx-44		Overhead Storage



Overhead Storage

Model #	List	Description
NAP-39-xxx		66x15x36H
NAP-07-xxx		60x15x36
<i>**Not available in WHT</i>		



Hutch

Model #	List	Description
NAP-53-xxx		35.5x14x36H
NAP-34-xxx		48x15x36H
<i>**Not available in WHT</i>		
NAP-84-xxx		42x42x36H Corner Hutch
<i>**Not available in NAS, PCW, SGW or WHT</i>		



NAP-WM36-CHY
(2qty.)

L-Shape includes NAP-82R, 92 & 80 in Cherry \$1,935



NAPURB-WM36DG



NAPURB-WM48DG

Wall-Mount Overhead Storage

Model #	List	Description
NAP-WM36-xxx		36x15x17H
NAP-WM48-xxx		48x15x17H
<i>**WM36 & WM48 not available in WHT</i>		
NAPxxx-WM36DG		36x15x17H
NAPxxx-WM48DG		48x15x17H

Accessories

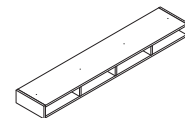

Horizontal Organizer, Black
Fits NAP41, 42 & 44
NAP-HO-BLK

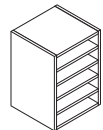

Vertical Organizer, Black
12.5x12.5x18.5H
NAP-VO-BLK

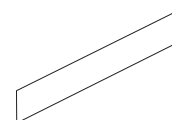

Tackboard for
NAP41/42/44, SON44
65x17.5
NAPTB-3
A B
C R

STORAGE | Tuxedo Storage, Filing & Hutches

STORAGE & FILING



3-Shelf Bookcase/Open Hutch TUX-55 | 63-11A653RHM Chair

Features

- Hutches feature 6 paper shelves; integrated cord-drop at base of back panel; and choice of wood or glass/aluminum doors
- Storage credenzas available with any combination of lateral file (12NT), multifile (69NT) and storage cabinet (13NT) modules
- Floating top design with angled edges
- Silver finish reveal and angled base trim
- Silver, solid-metal drawer pulls
- Drawer pull options on page 26

Available Finishes



SGW
Slate
Grey



WHTSGW
White Top
Slate Grey
Base



DKR
Dark
Roast



PCW
Park
City



TUX-12-SGW

TUXSGW-13

TUXDKR-69



TUXWHT-42

72" Hutch 72x16x42H

Model #	List	Description
TUXxxx-42		w/Glass Alum. Doors
TUXxxx-44		with Wood Doors



MultiFile
Storage
Credenza
72x24
TUXxxx-TYP204



Lateral File/
Storage Credenza
72x24
TUXxxx-TYP205



Double
Lateral File
Credenza
72x24
TUXxxx-TYP206



4-Door Storage
Credenza
72x24
TUXxxx-TYP207

2-Drawer
Lateral File
36x24x30H
TUX-12-xxx

2-Door
Storage Cabinet
36x24x30H
TUXxxx-13

MultiFile
Cabinet
36x24x30H
TUXxxx-69

Sonoma Veneer Storage, Filing & Hutches



SON-13
shown w/
SON55

SON-56

SON-55



2-Drawer Lateral File SON-12 & 3-Shelf Bookcase/ Open Hutch SON-55

Bookcases

Model #	List	Description
SON-12		37x20x29H, Lateral File
SON-13		37x20x29H, Storage Cabinet
SON-55		36x14x42H, Open Hutch.
SON-56		36x14x70, 5-Shelf Bookcase

Features

- Select hardwood veneers book-matched
- Solid hardwood edges
- Cherry finish with medium sheen
- Fingerpull design drawer fronts
- Coordinating wood drawer interiors
- Pedestals include single-key locking, five-sided drawer boxes, pre-installed filing hardware for legal/letter filing and full-extension, ball-bearing drawer slides
- 2, 3 and 4-drawer lateral files with pre-installed metal filing hardware and anti-tilt feature



Storage

Model #	List	Description
SON-109		37x20x56H, 4-Drwr Lat File
SON-51		37x19x70, Wardrobe Storage
SON-52		37x19x70, Storage File



Storage

Model #	List	Description
SON-10		72x20x29H, Storage Credenza (not shown)
SON-50		72x20x29H, 4-Door Credenza

Features

- Hardwood veneers on horizontal and vertical surfaces
- Book-matched veneer on vertical surfaces
- Royal Cherry with satin polyurethane finish
- Matching drawer interiors
- Felt-lined box drawers
- Full-extension file drawers with legal/letter filing
- Single-key locking located on inside of pedestals; front-locking lateral file and storage cabinet



4-Door Hutch
72x14x45H
TOW-44-CHY



Overhead Storage Hutch
72x15x45H
TOWCHY-84



Open Hutch 36 x 20 x 45H TOW-53-CHY List:
2-Door Storage Cabinet 36 x 20 x 30H TOW-13-CHY List:



Single Door Wardrobe
24x24x75H
TOW-151-CHY



4-Drawer Lateral File
36x20x54H
TOW-109-CHY
ships assembled in 1 ctn



4-Door Credenza
72x20x30H
TOW-50-CHY



2-Drawer Lateral File
36x20x30H
TOW-12-CHY



Townsend 3-Piece Wall Unit 90 x 14 x 72H TOWCHY-TYPWALL List:



TOWCHY-TYPWALL2



TOWCHY-TYPWALL4



TOWCHY-TYPWALL3

Typical Wall Units

Model #	List	Description
TOWCHY-TYPWALL		90x14x72H 1 WU Bkcs w/Doors + 2 WU Bkcs
TOWCHY-TYPWALL2		90x14x72H 2 WU Bkcs w/Doors + 1 WU Bkcs
TOWCHY-TYPWALL3		90x14x72H 3 WU Bookcase
TOWCHY-TYPWALL4		90x14x72H 3 WU Bookcase w/Doors

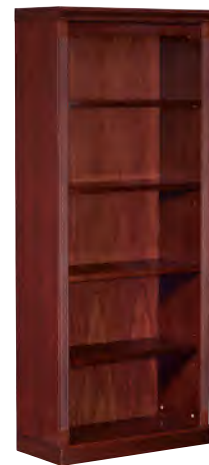

Wall Unit Bookcase
30x14x72H
TOW-156-CHY



Wall Unit Bookcase w/Doors
30x14x72H
TOW-113-CHY



VF4DR-x
4-Drawer Vertical File
Letter Width
Safety Interlock
15.25"W x 26.5"D x 52"H

Finish



G
Light Grey

B
Black

Features

- Commercial grade, all-metal materials
- Factory-built and welded
- Ships fully assembled
- Letter filing front-to-back
- Full-height drawers
- Full-extension, ball-bearing drawer slides
- Anti-tilt safety mechanism on all drawers
- Removable lock cores



VF2DR-x
2-Drawer Vertical File
Letter Width
Safety interlock
15.25"W x 26.5"D x 28.25"H

Storage Cabinets



ST723618-x
5-Shelf Locking Storage Cabinet
4 adjustable shelves
36 x 18 x 72H



Finish



B
Black

G
Grey



ST423618-x
2-Shelf Locking
Storage Cabinet
1 adjustable shelf
36 x 18 x 42H



Features

- Multipurpose all-steel storage units with adjustable shelves
- 270-degree opening doors with lock
- Heavy-gauge steel and powdercoat finish coordinates with metal lateral files & pedestals
- Optional extra shelves
- Assembly required



Features

- 2, 3, 4 & 5-drawer all-metal files
- 6 color options
- Side-to-side Letter, Legal & A4 filing
- Full-extension, steel ball-bearing drawer slides
- Safety interlock allows only one drawer to open at a time
- Integrated full-width pull design for easy opening of drawers
- Random-keyed, core-removable locks with replacement cores in multiple numbers available for customized security
- Adjustable leg levelers
- Complies with ANSI/BIFMA standards covering 21 different testing sections
- Optional front-to-back filing rails (LF100)



LF536-B

42" Wide Files

42x20

- LF242-x** 2 Drawers
- LF342-x** 3 Drawers
- LF442-x** 4 Drawers
- LF542-x** 5 Drawers

Finish



G Grey

B Black

36" Wide Files

36x20

- LF236-x** 2 Drawers
- LF336-x** 3 Drawers
- LF436-x** 4 Drawers
- LF536-x** 5 Drawers

Finish



B Black

SV Silver

WH White

HF Inertone Light (NJ only)

30" Wide 2-Drawer Files

29.75x19.75

- LF230-B** Black
- LF230-SV** Silver
- LF230-WH** White



BIFMA-tested, steel ball-bearing drawer slides.



Standard random locking with replaceable lock cores and multiple lock numbers available.

Laminate Tops for 36" Wide Files

Laminate Tops match our laminate casegoods and systems worksurfaces. Both 36" & 72" wide tops are available in four colors.



Shown in Urban Walnut:
LFT7220 72" Wide Top fits (2) 36" wide lateral files



Shown in Urban Walnut:
LFT3620 36" Wide Top fits (1) 36" wide lateral file

Finish



URB Urban Walnut

SGW Slate Grey

WHT White

*Does not match White metal finish

ESP Espresso





Introducing a new Mobile Desk featuring modern, mixed-materials design and built for motion. All-steel chassis includes heavy-duty metal pedestal, support bar and leg. Durable laminate tops. Versatility and functionality for all types of areas, ranging from industrial to classroom and more!

Features

- Mobile and fixed-position use
- Pedestal can be located on User's Left or Right
- Easy-moving with 6 casters
- Secure in place with 4 locking casters
- Bullet-shaped, 1" -thick Grey top
- Optional PET modesty panel
- Inverted Y design metal leg
- Heavy-duty metal pedestal with 2 box drawers, 1 file drawer
- Letter filing front-to-back or Legal filing side-to-side
- Full-extension, ball-bearing drawer slides
- Lock with replaceable core
- TAA compliant

Finish



B Black

SV Silver

Option	List	Description
LF-LK1		Lock Core + 2 Keys
LF-KM		Master Key
LF-KC		Change Key
LF-KB		Blank Key





MDM48GGSS Mobile Desk 48x24 with Modesty Panel

Grey/Silver

MDM48GGBB Mobile Desk 48x24 with Modesty Panel

Grey/Black

Overall: 48W x 24D x 29H
Kneespace: 26"
Carton Wt: 102 lbs.
Cube: 11.2

Options: LF-LK1

Note: Assembly required

LTL: Yes (ships in 2 cartons)

Consists of: MD4824M-SV & MDPED-SV



MD48GSS Mobile Desk 48x24 without Modesty Panel

Grey/Silver

MD48GGBB Mobile Desk 48x24 without Modesty Panel

Grey/Black

Overall: 48W x 24D x 29H
Kneespace: 26"
Carton Wt: 99 lbs.
Cube: 11.2

Options: LF-LK1

Note: Assembly required

LTL: Yes (ships in 2 cartons)

Consists of: MD4824-SV & MDPED-SV



MDM60GGSS Mobile Desk 60x24 with Modesty Panel

Grey/Silver

MDM60GGBB Mobile Desk 60x24 with Modesty Panel

Grey/Black

Overall: 60W x 24D x 29H
Kneespace: 38"
Carton Wt: 111 lbs.
Cube: 12.2

Options: LF-LK1

Note: Assembly required

LTL: Yes (ships in 2 cartons)

Consists of: MD6024M-B & MDPED-B



MD60GSS Mobile Desk 60x24 without Modesty Panel

Grey/Silver

MD60GGBB Mobile Desk 60x24 without Modesty Panel

Grey/Black

Overall: 60W x 24D x 29H
Kneespace: 38"
Carton Wt: 108 lbs.
Cube: 12.2

Options: LF-LK1

Note: Assembly required

LTL: Yes (ships in 2 cartons)

Consists of: MD6024-B & MDPED-B

DESKS

RECEPTION / LOUNGE



Napa Reception Desk Shell NAP-122-CHY | Napa Reception Return NAP-125-CHY | Glass Floating Top NAP-123
 FF Pedestal NAP-74-CHY | Lateral File NAP-12-CHY and Storage Cabinet with Glass/Wood Doors NAPCHY-212DC shown w/Napa BBF Pedestal NAP-65-CHY

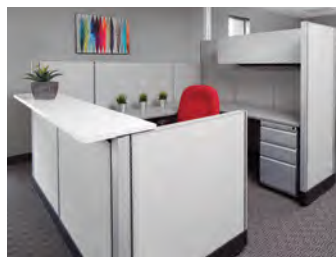

Transaction Counters 5' & 6' available with Systems workstations for multiple configurations.



Sonoma Wood Veneer
 Reception Desk 72x72x43H
SON-TYP19



Reception

Model #	List	Description
SON-122		Reception Desk
SON-124		Counter for SON-125
SON-125		Reception Return
SON-19		Coffee Table
SON-20		End Table

Finish

	CHY Sonoma Cherry
--	----------------------



Napa Laminate
 Reception Desk 71x77x42H
NAPxxx-TYP19

Reception

Model #	List	Description
NAP-122		Reception Desk Shell
NAP-123		Glass Floating Top
NAP-125		Reception Return Shell
NAP-121		48" Reception Desk Shell
<i>NAP-121 not available in CHY, MAH & URB</i>		
NAP-126		48" Glass Floating Top
NAP-20		End Table



SGW Slate Grey	URB Urban Walnut	WHT White	NAS Natty Ash
PCW Park City	ESP Espresso	CHY Cherry	MAH Mahogany

Townsend Wood Veneer
 Reception Desk 72x37x45.5H
TOWCHY-TYP19

Finish

	CHY Royal Cherry
--	---------------------



NAP97ESP-EC3 \$630 | **R101** Dillon Snow \$700 (shown above)
 A:
 Napa Guest Chair Full Cushion Back, Espresso
 23 x 23.75 x 32.75H

Finish



SGW
Slate Grey



URB
Urban Walnut



ESP
Espresso



CHY
Cherry



MAH
Mahogany



NAP95MAH-EC3
 C:
 Napa Guest Chair
 Mahogany/
 Black Bonded Leather
 22.5 x 22 x 31H
 Finishes: *ESP & MAH*

NAP91SGW-3
 Napa Guest Chair
 Slate Grey/Black Fabric
 22.75 x 22.75 x 31.5H
 Finishes: *ESP & SGW*

Finish



CHY Dark Cherry



SON79CHY-3
 A:
 Sonoma Upholstered Back Guest Chair
 Black Fabric
 23.5 x 24.5 x 33.25H



SON77CHY-3 \$570
 Sonoma Wood Back Guest Chair
 Black Fabric
 23.5 x 24.5 x 33.25H

ACCENT SEATING Wood

RECEPTION / LOUNGE



A. WD580-U6

Visitor's Chair in Medium Oak Finish
w/Memory Foam Seat
22.75 x 25 x 32.25H



B. WD581-U6

Visitor's Chair in Park City Finish
w/Memory Foam Seat
22.75 x 25 x 32.25H



C. WD587-U6

Visitor's Chair in Cherry Finish
w/Memory Foam Seat
22.75 x 25 x 32.25H



D. WD588-U6

Visitor's Chair in Espresso Finish
w/Memory Foam Seat
22.75 x 25 x 32.25H



A

WD580-U6 Black
Medium Oak Finish



B

WD581-U6 Black, in Park City Finish



C

WD587-U6 Black, in Cherry Finish



D

WD588-U6 Black, in Espresso Finish



Faux Leather



PD3
Black



PD26
Pewter

Mid-Century Solids



M17
Green

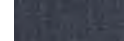

M19
Navy



M59
Cement

Woven



W12
Charcoal



W17
Indigo

MST55

Main Street Guest Chair
24 x 27 x 34H

- Padded arms
- Coil spring seat with sinuous spring support
- Espresso solid wood tapered legs



ETN

Ethan Accent Chair
30.5 x 26 x 29.75H

- Attractive and comfortable accent chair
- Covered in a high performance, easy care fabric
- Attractive espresso solid wood legs

Fabric



L37
Blue Denim



L38
Linen

Faux Leather



PD22
Cranberry



PD24
Cocoa



PD25
Camel



PD26
Pewter



SHE

Shelly Tufted Chair
27.75 x 30.5 x 33.75H

- Button tufted back and seat
- Tailored piping detail
- Coffee finish solid wood sculpted frame

Fabric



L32
Linen



K14
Azure



K21
Sea



K26
Charcoal



SEATING

RECEPTION / LOUNGE



- USB and USB-C charging station
- Available in black faux leather (-U65) or your choice of Custom Fabric
- Sinuous spring seat for durability and comfort
- Black metal finish legs



CUSTOM
FABRIC
PROGRAM

A. ARCT51

A
\$1,250 R: \$1,450
Arctic Armchair
37 x 30.75 x 30.25H

B. ARCT52

A:
C:
R
Arctic Loveseat
56 x 30.75 x 30.25H

C. ARCT53

A:
Arctic Sofa
77.5 x 30.75 x 30.25H



U65
Black Faux Leather



UL Certified
Power Unit





D. DTL51
Delta Armchair
34.75 x 30 x 32H

E. DTL53
Delta Sofa
60.25 x 30 x 32H

- Contemporary silhouette with generous cushioning for elevated comfort
- Covered in high-performance, easy-care fabric ideal for high-traffic spaces
- Sinuous spring seat construction enhances durability and long-term support
- Sturdy black metal legs add modern style and dependable strength
- Commercial-grade framework for lounges, lobbies, offices, and hospitality settings

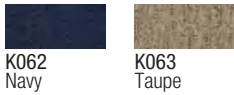

F. SL50551
Club Chair
37 x 33.25 x 34.75H

G. SL50552
Loveseat
59 x 33.75 x 36H



- Easy-clean Dillon upholstery
- 200k double-rubs
- Chrome legs
- Coffee & End Tables on pages 90-91

- Silver Ion technology kills and inhibits growth of bacteria, mold, mildew and fungi to promote clean interiors



SEATING SL5600 Series

RECEPTION / LOUNGE



PD28
Cream



SK2
Charcoal



A. SL5601
Lounge Chair
26 x 28.75 x 33.5H

B. SL5602
Lounge Loveseat
48 x 28.75 x 33.5H

C. SL5603
Lounge Sofa
63.5 x 28.75 x 33.5H

- Attractive modern style
- Quality-built, kiln-dried wood construction
- Superior, high-density foam seat
- Heavy-duty steel legs in polished chrome finish
- Anti-scratch floor glides
- Available in fabric and PU faux leather options



SK2
Charcoal



P52
Smoke



PD28
Cream



P52
Smoke

SL59400 / SL4400 Series



D. SL59401
Club chair
34.75 x 30 x 32H

E. SL59402
Loveseat
60.25 x 30 x 32H

F. SL59403
Sofa
82.25 x 30 x 32H

- Durable black faux leather upholstery ideal for high-traffic spaces
- Cherry finish solid wood legs for a classic professional look
- Ships assembled with legs unmounted for convenience
- ANSI/BIFMA tested for commercial-grade durability

U65
Black Faux Leather



G. SL4411R
Mid-Century Club Chair
27 x 28.25 x 33.25H

H. SL4422R
Mid-Century Loveseat
44 x 28.25 x 33.25H

I. SL4433R
Mid-Century Sofa
64.5 x 28.25 x 33.25H

- 5" thick fiber-wrapped seat cushions
- Sinuous wire seat suspension
- Solid wood legs and apron
- Coffee finish
- Coffee & End Tables on pages 90-91

 MC3
Navy

 MC4
Charcoal



Wall Street Collection

A. WST51A

Armchair
30.5 x 28 x 31H

- Modern sophisticated style
- Covered in high-performance faux leather
- Seperate pieces will build custom sectional
- Modular in design
- Button tufted back
- Chrome base
- Box-spring seat cushion

B. WST51LF

Left Facing Armchair
27.25 x 28.5 x 31H



B18
Black Faux Leather



E34
Espresso Faux Leather



W32
White Faux Leather

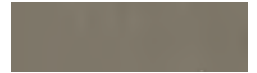

U22
Smoke Faux Leather

C. WST51P

Charging Center Console
6.5 x 28.25 x 20H

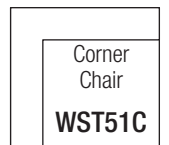
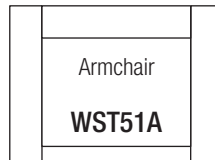
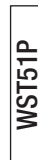
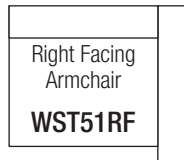
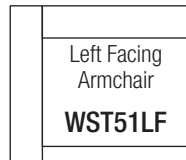

D. WST51C

Corner Chair
28 x 28 x 31H

E. WST51N

Armless Chair
23 x 28 x 31H

F. WST51RF

Right Facing Armchair
27 x 28 x 31H





Coffee & End Tables on pages 90-91.

Popular Configurations



- Designed to offer charging station console to our custom sectional
- AC and USB 3.0 Charging Station
- Solid laminate accessories work surface



SEATING Pacific

RECEPTION / LOUNGE



Pacific Collection



- Covered in high performance, easy care fabric
- Sinuous spring seat for durability and comfort
- Chrome finish legs



Dillon



R100
Lipstick

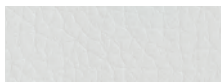

R101
Snow

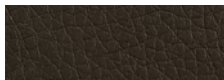

R102
Java



R103
Stratus



R104
Buff



R105
Blue

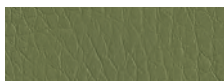

R106
Sage



R107
Black



R108
Ocean

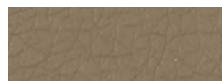

R109
Balsa



R111
Graphite



R112
Steel



R113
Luggage

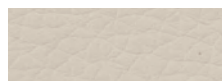

R114
Sandy

A. PAC51

Dillon:
Pacific Armchair
32 x 30.5 x 29.5H

B. PAC52

Dillon:
Pacific Loveseat
51.5 x 30.5 x 29.5H

C. PAC53

Dillon:
Pacific Sofa
72.5 x 30.5 x 29.5H

Silver Ion Technology

Fabric is treated with Silver Ion Technology to protect the fabric from mold, mildew, and odor-causing bacteria. Embedded directly into the fabric, this technology helps the product stay cleaner and fresher. Easy-clean with water or solvent-based cleaners. **Disinfects with 5:1 water/bleach solution.** PVC free. Phthalate and lead compliant. Heavy-duty 200,000 double-rub abrasion resistance.



Vinyl Faux Leather



V18
Black



V34
Espresso

A. PAC51 Vinyl:
Pacific Armchair

32 x 30.5 x 29.5H

B. PAC52 Vinyl:
Pacific Loveseat

32 x 30.5 x 29.5H

C. PAC53 Vinyl:
Pacific Sofa

72.5 x 30.5 x 29.5H



A. PAC51
Sergio Solids:
Pacific Armchair
32 x 30.5 x 29.5H

B. PAC52
Sergio Solids:
Pacific Loveseat
32 x 30.5 x 29.5H

C. PAC53
Sergio Solids:
Pacific Sofa
72.5 x 30.5 x 29.5H

Sergio Solids



M59
Cement



S76
Navy



S125
Taupe



S126
Sea Green

Custom Fabric

A. PAC51

Pacific Armchair
32 x 30.5 x 29.5H

B. PAC52

Pacific Loveseat
32 x 30.5 x 29.5H

C. PAC53

Pacific Sofa
72.5 x 30.5 x 29.5H



SEATING Atlantic

RECEPTION / LOUNGE



Atlantic Collection

Dillon

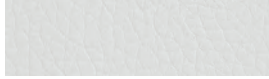

R101
Snow



R105
Blue



R107
Black



Silver Ion Technology

Fabric is treated with Silver Ion Technology to protect the fabric from mold, mildew, and odor-causing bacteria. Embedded directly into the fabric, this technology helps the product stay cleaner and fresher. Easy-clean with water or solvent-based cleaners. **Disinfects with 5:1 water/bleach solution.** PVC free. Phthalate and lead compliant. Heavy-duty 200,000 double-rub abrasion resistance.

Dillon

A. ATL51

Atlantic Armchair
32 x 30.5 x 29.5H

B. ATL52

Atlantic Loveseat
51.5 x 30.5 x 29.5H

C. ATL53

Atlantic Sofa
72.5 x 30.5 x 29.5H





- ATL51 includes one AC / USB 3.0 Charging Station
- ATL52 & ATL53 includes two AC / USB 3.0 Charging Stations
- Sinuous spring seat for durability and comfort
- Chrome finish legs



Custom Fabric
A. ATL51

Atlantic Armchair
32 x 30.5 x 29.5H

B. ATL52

Atlantic Loveseat
51.5 x 30.5 x 29.5H

C. ATL53

Atlantic Sofa
72.5 x 30.5 x 29.5H



Coffee & End Tables on pages 90-91.

TABLES Coffee and End

RECEPTION / LOUNGE



Brooklyn Table Collection



MG0920R-BK
MG0920R-WH

Brooklyn Round End Table
22 x 22 x 20.25H
Brushed Nickel with
Matte White or Black Top



MG0922S-BK
MG0922S-WH

Brooklyn Square End Table
22 x 22 x 20.25H
Brushed Nickel with
Matte White or Black Top



MG1230R-BK
MG1230R-WH

Brooklyn Round Coffee Table
30 x 30 x 20.25H
Brushed Nickel with
Matte White or Black Top



MG1242S-BK
MG1242S-WH

Brooklyn Rectangle Coffee Table
42 x 24 x 16.25H
Brushed Nickel with
Matte White or Black Top



MG0920R-NB

Brooklyn Round End Table
20 x 20 x 20H
Brushed Nickel with
Clear Glass Top



MG0922S-NB

Brooklyn Square End Table
22 x 22 x 20H
Brushed Nickel with
Clear Glass Top



MG1230R-NB

Brooklyn Round Coffee Table
30 x 30 x 16H
Brushed Nickel with
Clear Glass Top



MG1242S-NB

Brooklyn Rectangle Coffee Table
42 x 24 x 17H
Brushed Nickel with
Clear Glass Top





Wall Street Collection

WST09-BK
Black

WST12-BK
Black



**WST09 | WST09-BK
WST09-WH**
Wall Street End Table
22 x 15.75 x 18.5H



**WST12 | WST12-BK
WST12-WH**
Wall Street End Table
44 x 22 x 15H

Durable laminate, scratch resistant surface
Modern chrome frame • Skid-free floor caps



SON-19-CHY
Sonoma Coffee Table
48 x 24 x 20H



SON-20-CHY
Sonoma Coffee Table
24 x 24 x 20H

Select hardwood veneers • Compound radius corners
Dark Cherry finish • Good match for lounge series seating



NAP-20-xxx
Napa End Table
24 x 24 x 20H



Lane Collection



LN3618
Lane Coffee Table
36 x 36 x 18H



LN3620
Lane End Table
20 x 20 x 22.25H



LN3630
Lane Console Table
36 x 15 x 30.5H

- Contemporary Style
- Applied joinery detail
- Lower shelf open display

- Solid 1.8" x 1.8" wood legs
- Wood top with MDF core 3/4" thick
- Simple assembly



SEATING

SL2900 Series

RECEPTION / LOUNGE



*Brooklyn
Coffee & End
Tables on
page 90.*

C

U6
Black
Faux
Leather

A



B

Black faux leather • Silver finish legs • Fully assembled



36WH
White

36BK
Black



36SV Silver

Power Anywhere Station

Convenient, easy-access
A/C & USB charging anywhere. Includes (3) A/C
outlets plus 1 each USB, Type-C & Type-A ports.

PAS311-36
12.75 x 12.55 x 35.75H



Attractive contrasting stitch detail



R43
Sand
Faux Leather



R44
Grey
Faux Leather



R45
Navy
Faux Leather

BRK
Brooks Accent Chair
25.25 x 28.25 x 31H

Home/Office Primo Sit-to-Stand Adjustable Electric Tables

DESKS

OFFICE



Accessory hooks



Programmable height memory control



Desktop adjusts from 29" to 47" high

D. PM06066-LG

Primo Sit-to-Stand L-Desk
59 x 65.5 x 29.5-47H

Electric one-touch up and down controls w/4-programmable height memory, accessory hooks
Black Base/Light Grey Top (-LG)

Enjoy the flexibility of sitting, standing, or utilizing your favorite stool with our essential electric sit-to-stand desks. Adjust the desk to your liking throughout the day with a simple touch of the electric up-to-down controls or use our programmable memory. The expansive work surface will allow plenty of room for your laptop, monitor and files. Keep headphones or pack in easy reach with an accessories hook. Sleek clean lines paired with heavy-duty steel frame make these sit-to-stand desks an essential part of every home office. Enjoy simple assembly.

E. PM04825WCF

Primo 48" Sit/Stand Electric Desk
47.25 x 25.5 x 28.5-47H

One-Touch up and down control with 4-programmable height memory
2 USB Ports, handy cup holder, 100 lbs. desktop weight capacity
White Carbon Fiber

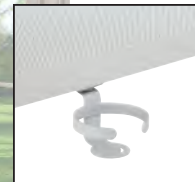

Cup holder



Convenient hook



Programmable height memory control

F. PM06024-WH/PM06024B-LG

Primo 60" Sit/Stand Electric Desk
59 x 23.75 x 29.5-47H

Electric one-touch up and down controls w/programmable height memory, convenient hook, laminate top
White Base/White Top (-WH)
Black Base/Light Grey Top (-LG)



G. PM04823-WH/PM04823B-LG

Primo 48" Sit/Stand Electric Desk
47.25 x 23.75 x 29-46.5H

Electric one-touch up and down controls with programmable height memory, convenient hook, laminate top
White Base/White Top (-WH)
Black Base/Light Grey Top (-LG)





BC9603
Bariatric Patient Chair
32.75 x 27.75 x 35.25H
29" seat width
500 lbs. weight capacity
Shown in Dillon R103 Stratus



BC9601
Bariatric Patient Chair
24.75 x 27.75 x 35.25H
21" seat width
300 lbs. weight capacity
Shown in Dillon R102 Java

BC9602
Bariatric Patient Chair
29 x 27.75 x 35.25H
26" seat width
400 lbs. weight capacity
Shown in Dillon R106 Sage



Wall-saver design protects walls in all types of facilities.

Tubular steel frame with Titanium EPD finish and black floor-protection caps

Separated seat/back for cleaning

BC9600 Series

is designed with upsized dimensions and engineered to with elevated weight capacities to accommodate larger occupants.

Healthcare Upholsteries

Castillo and Dillon **disinfect with 5:1 water/bleach solution** for enhanced cleanability. Treated with Silver Ion Technology. 200K double-rubs durability.

Dillon



Castillo



Silver Ion Technology

Fabric is treated with Silver Ion Technology to protect the fabric from mold, mildew, and odor-causing bacteria. Embedded directly into the fabric, this technology helps the product stay cleaner and fresher. Easy-clean with water or solvent-based cleaners. **Disinfects with 5:1 water/bleach solution.** PVC free. Phthalate and lead compliant. Heavy-duty 200,000 double-rub abrasion resistance.



Has achieved GREENGUARD certification



A

A. 55094S
 Big & Tall Healthcare Guest Chair
 27 x 29.5 x 34.5H
 300 lbs. weight capacity
 Shown in Dillon Black -R107



R107
 Dillon Black

*See Dillon and Castillo
 Color Options, page 94*



B

B. 55099S
 Big & Tall Healthcare Guest Chair
 31 x 29.5 x 34.25H
 500 lbs. weight capacity
 Shown in Dillon Black -R107



55052B
 Big & Tall Guest Chair
 Dillon or Castillo
 28 x 24.75 x 33H
 400 lbs. weight capacity
 Shown in Dillon Black -R107



55054B
 Big & Tall Armless Guest Chair
 Dillon or Castillo
 24.75 x 24.5 x 33H
 500 lbs. weight capacity
 Shown in Castillo Breezy -K003



55051B
 Big & Tall Guest Chair
 Dillon or Castillo
 32.75 x 24.75 x 33H
 500 lbs. weight capacity
 Shown in Dillon Black -R107

See Dillon and Castillo Color Options, page 94

EXECUTIVE LEATHER

SEATING



8200
 Deluxe High Back Executive Chair
 28.25 x 25.75 x 45.25-48H
 Functions: Pneumatic Seat,
 Mid-Pivot Knee Tilt, Tilt Tension



8201
 Deluxe Mid-Back Executive Chair
 28.25 x 25 x 40-42.75H
 Functions: Mid-Pivot Knee Tilt,
 Pneumatic Seat, Tilt Tension

Black Top Grain Leather &
 Polished Aluminum Base



EC3 Black Leather &
 Industrial Steel Base



EC21 Taupe Leather &
 Industrial Steel Base

EC42
 Charcoal Grey Leather &
 Industrial Steel Base

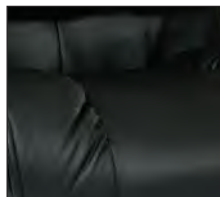

9333E
 Conference Chair
 28.75 x 30 x 41.5-45.75H
 Functions: Pneumatic Seat, 2-to-1 Synchro Tilt,
 Tilt Tension Cantilever Arms





A



B

A. 920350C

High Back Manager's Chair

29 x 27.25 x 44.25-48H

-R101, -R105, -R107, -R112

Functions: Pneumatic Seat, Tilt Tension, Locking Tilt

B. 920351C

Mid-Back Manager's Chair

26.75 x 26 x 37.5-41.25H

-R101, -R105, -R107, -R112

Functions: Pneumatic Seat, Tilt Tension, Locking Tilt

C. 99662CDB

Manager's Chair

28.75 x 27 x 41.25-46.5H

-R105, -R107

Functions: Adjustable Back, Seat Slider, 2-to-1 Synchro Tilt w/3-position Lock, Tilt Tension



C



R101
Dillon Snow



R105
Dillon Blue



R107
Dillon Black



R112
Dillon Steel

Silver Ion Technology

Fabric is treated with Silver Ion Technology to protect the fabric from mold, mildew, and odor-causing bacteria. Embedded directly into the fabric, this technology helps the product stay cleaner and fresher. Easy-clean with water or solvent-based cleaners. **Disinfects with 5:1 water/bleach solution.** PVC free. Phthalate and lead compliant. Heavy-duty 200,000 double-rub abrasion resistance.

EXECUTIVE LEATHER

SEATING



3680



36806

36806

28.5 x 27 x 46.5-55H

3680 \$1,100

Light Air Grid® Back

Manager's Chair

28.5 x 27 x 40.5-45H

Patent#

US20040262975 A1

Functions: 2-to-1 Synchro

Tilt, Pneumatic Seat,

Tilt Tension, Cantilever Arms



Top Grain Leather



Cantilever Platinum Finish Arms with PU Pads



335-E37P918P

Professional Light Air Grid®

Back Manager's Chair

27.75 x 24.25 x 43.25-47.25H

Patent# US2004/0262975A1

Functions: Pneumatic Seat,

2-to-1 Synchro Tilt, Height

Adjustable Arms, Tilt

Tension



27008

Breathable Mesh Back

Manager's Chair

28.75 x 26 x 51.75-57H

Patent# USD486656 S1

Functions: Pneumatic Seat,

2-to-1 Mid-Pivot Knee Tilt,

Adjustable Headrest, Tilt

Tension, Height Adjustable

Arms & Lumbar Support



Has achieved GREENGUARD certification



AIR GRID®



A. 5790E
 25.75 x 26.25 x 41.75-45.75H
B. 57906E \$925
 Dark Air Grid® Back
 Manager's Chair
 28.75 x 27.25 x 48-56.25H
 Functions: 2-to-1 Synchro Tilt,
 Pneumatic Seat, Tilt Tension,
 Height Adjustable Arms,
 Adjustable Headrest



867-E36N64R
 Manager's Chair
 29.25 x 29.25 x 40.75-45H
 Functions: Pneumatic Seat, 2-to-1 Synchro Tilt
 w/3-position Lock, Seat Slider, Cantilever Flip Arms,
 Tilt Tension, 3-Way Adjustable PU Padded Armrest



32-E33P918PHL

32-E33P918PHL
 Deluxe Bonded Leather Manager's Chair
 29.25 x 29.5 x 47.5-55.75H
32-E33P918P \$925
 29.25 x 29 x 41.5-45.75H
 Functions: Pneumatic Seat, 2-to-1 Synchro Tilt, Height
 Adjustable Arms, Tilt Tension, Adjustable Headrest



32-E33P918P





A



B



A. 818-31G9C18P
29.25 x 29.25 x 42-44H
B. 818-11G9C18P \$1,275
Executive Chair
27.25 x 24 x 42.75-45H
Functions: Pneumatic Seat, 2-to-1
Synchro Tilt w/3-position Lock,
Height Adjustable PU Padded
Arms, Tilt Tension, Seat Slider



C



C. 818A-41P9C1A8
Executive Chair
29.25 x 26.25 x 42-44.5H
Functions: Pneumatic Seat, 2-to-1
Synchro Tilt w/3-position Lock,
Height Adjustable PU Padded
Arms, Tilt Tension, Seat Slider

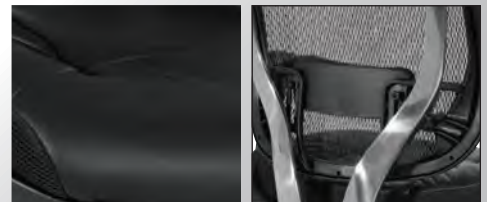



D. 639-F3T1N48PHX

Vertical Matrix Back
 Manager's Chair with Headrest
 29 x 27 x 47.25-56.75H
 Functions: Pneumatic Seat,
 2-to-1 Synchro Tilt, Seat Slider, Tilt
 Tension, Self-Adjusting Lumbar Support

Vertical Matrix Back
 Manager's Chair
 29 x 26.75 x 40.75-48H
 Functions: Pneumatic Seat, 2-to-1
 Synchro Tilt, Seat Slider, Tilt Tension,
 Self-Adjusting Lumbar Support



E



Height Adjustable Arms



2-Way Adjustable Headrest



Back Height Adjustment



F. 639-T11N48PHX

Vertical Matrix Seat & Back Manager's Chair
 29 x 26.25 x 47.25-56.75H
 Functions: Pneumatic Seat, 2-to-1 Synchro Tilt, Back Height
 Adjustment, Tilt Tension, Seat Slider, Self-Adjusting Lumbar
 Support, 2-Way Adjustable Headrest



G

G. 639-T11N48P
 Vertical Matrix Seat & Back Manager's Chair
 29 x 26.5 x 40.75-47.75H
 Functions: Pneumatic Seat, 2-to-1 Synchro
 Tilt, Back Height Adjustment, Tilt Tension,
 Seat Slider, Self-Adjusting Lumbar Support,
 2-Way Adjustable Headrest



Height Adjustable
 Arms

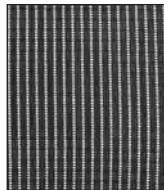

Vertical Matrix
 Seat & Back





529R-R22N1F2
Professional R2 SpaceGrid Back
Manager's Chair
29 x 25.25 x 39.25-43.5H
Functions: 2-to-1 Synchro Tilt,
Pneumatic Seat, Tilt Tension,
Adjustable Lumbar Support

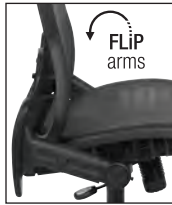

FUN
COLORS
PAIRED PROGRAM
(Seat only)



R2 SPACEGRID



Memory Foam
Seat

529R-3R2N1F2
Fun Colors: | Dillon:

Professional R2 SpaceGrid Back
Manager's Chair
29 x 25.5 x 39.25-43.5H
Functions: 2-to-1 Synchro Tilt,
Pneumatic Seat, Tilt Tension,
Adjustable Lumbar Support



A

Black Mesh
Seat

A. 2300
Breathable Mesh Back
Manager's Chair
26.75 x 25.5 x 42-46H
Patent# USD486657 S1
Functions: 2-to-1 Synchro
Tilt, Pneumatic Seat, Tilt
Tension, Adjustable
Lumbar Support,
Adjustable Arms



B

Bonded Leather
Seat

B. 2400E
Breathable Mesh Back
Manager's Chair
27 x 26 x 42-46H
Functions: 2-to-1 Synchro Tilt,
Pneumatic Seat, Tilt Tension,
Adjustable Lumbar Support,
Adjustable Arms

AIR GRID[®]



C

Black Mesh
Seat

C. 5540
Dark Air Grid[®] Back Manager's Chair
28.75 x 28.5 x 41.5-45.75H
55403 \$825
Dark Air Grid[®] Back Manager's Chair
with Adjustable Headrest
27 x 27.75 x 47.75-56.25H
Patent# US20040262975 A1
Functions: 2-to-1 Synchro Tilt,
Pneumatic Seat, Tilt Tension,
Adjustable Lumbar Support, Adjustable Arms



Has achieved GREENGUARD certification



D. 5500®
 Fun Colors:
 R107 / Dillon:
 Dark Air Grid® Back
 Task Chair
 28.75 x 25.25 x 38-42.25H
 Patent# USD510488 S1
 Functions: 2-to-1 Synchro Tilt,
 Pneumatic Seat, Tilt Tension,
 Height Adjustable Arms



E. 5500D
 Silver Ion Technology*
 Task Chair
 28.75 x 26.25 x 37.75-42H
 Functions: Pneumatic Seat,
 2-to-1 Synchro Tilt, Adjustable
 Arms, Tilt Tension

Dillon

 R100 R103 R105 R107
 Lipstick Stratus Blue Black

*See Page 94 for Silver Ion
 Technology for Details

F. 5700E
 Dark Air Grid® Back
 Task Chair
 28.75 x 26.25 x 37.75-42H
 Functions: Pneumatic Seat,
 2-to-1 Synchro Tilt, Adjustable
 Arms, Tilt Tension



G. 5505
 Dark Air Grid® Back
 Visitor's Chair
 24.5 x 25.5 x 37.25H
 Patent# USD510488 S1

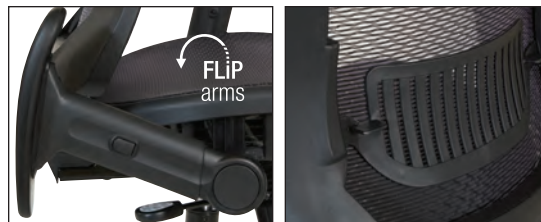

H. 515-77N1F2
 Dark Air Grid® Back
 Manager's Chair
 28.75 x 25 x 38.75-42H
 Functions: 2-to-1 Synchro
 Tilt, Pneumatic Seat, Tilt
 Tension, Height Adjustable
 Flip Arms

I. 515-F37N1F2
 Dark Air Grid® Back
 Manager's Chair
 28.75 x 25 x 38.75-43H
 Functions: 2-to-1 Synchro Tilt,
 Pneumatic Seat, Tilt Tension,
 Height Adjustable Flip Arms



Has achieved GREENGUARD certification





317W-W1C1F2W-7

3M
Black Mesh

FUN
COLORS
FABRIC PROGRAM
(Seat only)

317W-W1C1F2W-3M

Fun Colors: | Dillon:
White Frame Manager's Chair
26 x 24.75 x 40.5-44.75H
Functions: 2-to-1 Synchro Tilt,
Pneumatic Seat, Tilt Tension,
Height Adjustable 2-Way Flip Arms



Height
Adjustable
Lumbar
Support

317W-W1C1F2W

White Frame Manager's Chair
26 x 24.75 x 40.5-44.75H
Functions: 2-to-1 Synchro Tilt,
Pneumatic Seat, Adjustable Lumbar
Support, Height Adjustable 2-Way
Flip Arms



95673-5882

Fun Colors: | Dillon:
ProGrid[®] Mid-Back Manager's Chair
25.75 x 24.75 x 38-44H
Functions: Pneumatic Seat,
2-to-1 Synchro Tilt w/3-Position
Lock, Seat Slider, Tilt Tension,
Ratchet Back Height Adjust,
Height Adjustable 2-Way Flip Arms

95672-5882

Fun Colors:
Dillon
ProGrid[®] High Back Manager's Chair
25.5 x 23.25 x 43-48.75H
Functions: Pneumatic Seat,
2-to-1 Synchro Tilt w/3-Position Lock,
Tilt Tension, Seat Slider, Ratchet Back
Height Adjust, Height Adjustable 2-Way
Flip Arms

5882
Dove Ivory

FUN
COLORS
FABRIC PROGRAM
(Seat only)



Has achieved GREENGUARD certification



5200W-6

5200W

Fun Colors:

Dillon & Castillo:

White Frame Manager's Chair

28.5 x 26.75 x 37-41.25H

Functions: Pneumatic Seat,
2-to-1 Synchro Tilt, Height Adjustable
Flip Arms, Tilt Tension



Colored Mesh

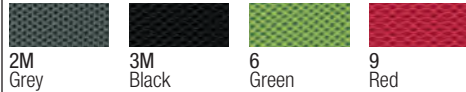

Linen



Dillon



Castillo

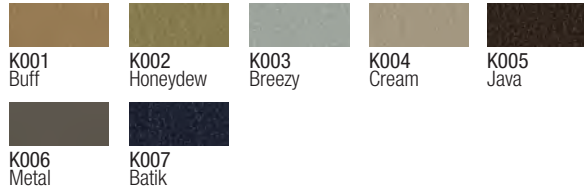

Silver Ion Technology

Fabric is treated with Silver Ion Technology to protect the fabric from mold, mildew, and odor-causing bacteria. Embedded directly into the fabric, this technology helps the product stay cleaner and fresher. Easy-clean with water or solvent-based cleaners. **Disinfects with 5:1 water/bleach solution.** PVC free. Phthalate and lead compliant. Heavy-duty 200,000 double-rub abrasion resistance.



5200W-K007

Has achieved GREENGUARD certification





Built-In Lumbar Support



AIR GRID®



AIR GRID®



Height Adjustable Lumbar Support



A

Memory Foam Seat



B

Memory Foam Seat



Intensive use and 24/7 applications



231 Icon Black



C

A. 55247SM-231

Dillon:
24/7 Air Grid® Task Chair
28.5 x 26.5 x 37.75-42H
Functions: 2-to-1 Synchro Tilt, Pneumatic Seat, Tilt Tension, Seat Slider, Height Adjustable Arms

B. 63247SM-231

Dillon:
24/7 Air Grid® Manager's Chair
29 x 29 x 41-45.5H
Functions: Pneumatic Seat, 2-to-1 Synchro Tilt, Seat Slider, Tilt Tension, Height Adjustable Arms

C. 54666-231

Dillon:
24/7 Multi-Shift Executive Ergonomic Chair
Titanium EPD Finish
28.5 x 27 x 37.5-41.5H
Functions: Pneumatic Seat, 2-to-1 Synchro Tilt w/3-Position Lock, Tilt Tension, Seat Slider, Height & Width Adjustable Arms



Increased Foam Density Contoured Seat & Back

Dillon

R100 Lipstick	R101 Snow	R102 Java
R103 Stratus	R104 Buff	R105 Blue
R106 Sage	R107 Black	R108 Ocean
R109 Balsa	R111 Graphite	R112 Steel
R113 Luggage	R114 Sandy	





71142MHR-3
 Manager's Chair w/Headrest
 29.25 x 26.25 x 44.75-50.25H
 Functions: Self-Adjusting 4-to-1 Synchro Tilt, Backrest Lock, Anti-Kickback, Seat Slider, 3-Way Height Adjustable Arm, Self-Adjusting Lumbar Support, Adjustable Headrest



71142M-3
 Manager's Chair
 29.25 x 26.25 x 40.5-43.25H
 Functions: Self-Adjusting 4-to-1 Synchro Tilt, Backrest Lock, Anti-Kickback, Seat Slider, 3-Way Height Adjustable Arm, Self-Adjusting Lumbar



71142HR-3
 Manager's Chair w/Headrest
 29.25 x 26 x 44.75-50.25H
 Functions: Self-Adjusting 4-to-1 Synchro Tilt, Backrest Lock, Anti-Kickback, Seat Slider, 3-Way Height Adjustable Arm, Self-Adjusting Lumbar Support, Adjustable Headrest



71142-3
 Deluxe Mid-Back Executive Chair
 28.25 x 25 x 40-42.75H
 Functions: Self-Adjusting 4-to-1 Synchro Tilt, Backrest Lock, Anti-Kickback, Seat Slider, 3-Way Height Adjustable Arm, Self-Adjusting Lumbar Support



MESH TASK

SEATING



69333-30

Soft Frame Task Chair
28 x 24.75 x 39.25-42.5H
Functions: Dual Function Control with Forward Pitch, Tilt Tension,
Seat & Back Angle Adjust, Height Adjustable PU Padded Arms



ProGRID®

30 FreeFlex® II Coal

F CUSTOM
FABRIC
PROGRAM



69393-30

Soft Frame Task Chair
Polished Aluminum Base
29 x 25.75 x 38.5-42.25H
Functions: Multi-Function Control, Seat Slider, Forward Pitch,
Pneumatic Seat, Tilt Tension, Seat and Backrest Angle Adjustment



69353-30

Soft Frame Task Chair
28 x 26 x 37.25-40.75H
Functions: Pneumatic Seat, 2-to-1 Synchro Tilt,
Height Adjustable Arms, Tilt Tension



92892-30

ProGrid® Back High Back Chair
 28 x 29 x 42.75-46.25H
 Functions: Pneumatic Seat,
 Multi-function, Tilt Tension, Seat
 Slider, Height, Width & Depth
 Adjustable Arms



92893-30

ProGrid® Back High Back Chair
 27 x 24 x 37.75-41.25H
 Functions: Pneumatic Seat, Ratchet Back Height
 Adjustment, Multi-function, Tilt Tension, Seat
 Slider, Height, Width & Depth Adjustable Arms

ProGRID®



30 FreeFlex® II Coal



CUSTOM
 FABRIC
 PROGRAM



K107
 City Park Domino



R105
 Dillon Blue



90662-30

ProGrid® Back Manager's Chair
 28 x 27 x 41.25-44.75H
 Functions: 2-to-1 Synchro Tilt, 3 Position Locking,
 Seat Slider, Tilt Tension, Height, Width & Depth Adjustable PU Padded Arms



30
 FreeFlex® II Coal



MESH TASK

SEATING



92553-30 | 92553-R107

ProGrid® Back Manager's Chair
 25.25 x 24.75 x 36.25-42.25H
 Functions: 2-to-1 Synchro Tilt, Ratchet
 Back Height Adjustment, Tilt Tension,
 Height Adjustable PU Padded Arms

ProGRID®



9093B-30
 9093B-R107



Mesh Back Visitor's Chair
 Sled Base
 26.5 x 24.75 x 36.25H





93720
 ProGrid® High Back Mesh Chair
 27.75 x 27.25 x 43-45.75H
 Functions: Synchro Control with Infinite Lock,
 Seat Slider, Adjustable Tilt Tension
 Height, Width & Depth Adjustable PU Padded Arms

ProGRID®



F CUSTOM
 FABRIC
 PROGRAM



97720-30
97720-R105 | 9720-R107

ProGrid® High Back Chair
 28.25 x 25.75 x 43.25-46H
 Functions: Synchro Control with Infinite
 Lock, Seat Slider, Adjustable Tilt Tension,
 Height, Width and Depth Adjustable PU
 Padded Arms

30 FreeFlex® II Coal



R105 Dillon Blue

Has achieved GREENGUARD certification



MESH TASK

SEATING



99653-30

Mesh High-Back Manager's Chair
29 x 25.75 x 40.75-46.75H
Functions: Pneumatic Seat,
2-to-1 Synchro Tilt, Adjustable Back,
2-Way Adjustable PU-Padded Arms, Tilt Tension,
Seat Slider



99893-30

Mesh High-Back Manager's Chair
29 x 25.75 x 42-48.25H
Functions: Pneumatic Seat,
Multi-function Control with Forward Tilt,
Adjustable Back, 2-Way Adjustable
PU-Padded Arms, Tilt Tension, Seat Slider

ProGRID®

30
FreeFlex® II Coal



92555

Air Mist Mesh Back Manager's Chair
26.75 x 24.5 x 36.25-42.5H

Features

- Breathable Air Mist mesh back
- Molded foam seat
- 2-to-1 synchro tilt control with adjustable tilt tension
- One-touch pneumatic seat height adjustment
- Height and width adjustable arms
- Ratchet back height adjustment



9206 Black/White

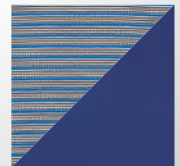

9278 Blue

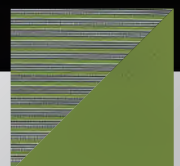

9279 Green



EM65151HR-3
 Mesh Back Manager's Chair
 w/Headrest
 28.5 x 26.5 x 45.5-52.75H
 Functions: Pneumatic, 2-to-1
 Synchro Tilt, Adjustable Flip Arms



EMM65151HR-3
 Mesh Back Manager's Chair
 w/Headrest
 28.5 x 26.75 x 45.5-52.5H
 Functions: Pneumatic, 2-to-1
 Synchro Tilt, Adjustable
 Flip Arms



98341-30

ProGrid® Ergonomic Task Chair
 28.25 x 25 x 40-42.75H
 Functions: Pneumatic, Dual Function,
 Ratchet Back Height Adjust,



98344-30 \$605
 A: \$630 B: \$655 C: \$705 R: \$755
 ProGrid® Ergonomic Task Chair
 with Adjustable Arms
 28.25 x 25 x 40-42.75H

2902-30
 ProGrid® Back Ergonomic Task Chair
 25 x 23 x 33.25-38.25H

Functions: Pneumatic, Multi-Task,
 Height Adjustable Back

29024-30
 ProGrid® Back Ergonomic Task Chair
 w/ Adjustable Arms
 26.5 x 25.75 x 34.75-41.25H
 A: \$530 B: \$555 C: \$580 R: \$605



29024-30



30
 FreeFlex® II Coal

2902-30



VENTILATED

SEATING



EM14622HR-2
 Mesh High-Back Manager's Chair with Headrest
 28.5 x 26.25 x 45.5-52.5H
 Functions: Pneumatic Seat, 3-Position Locking Tilt Control, Adjustable Lumbar Support, Height Adjustable Arms, Adjustable Headrest, Tilt Tension

2 Grey



3 Black

EM14622HR-3
 Mesh High-Back Manager's Chair with Headrest
 28.5 x 26.25 x 45.5-52.5H
 Functions: Pneumatic Seat, 3-Position Locking Tilt Control, Adjustable Lumbar Support, Height Adjustable Arms, Adjustable Headrest, Tilt Tension

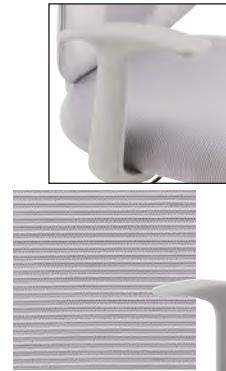

EM14623-2
 Mesh Back Manager's Chair
 24.5 x 22 x 39.25-43H
 Functions: Pneumatic Seat, 3-Position Locking Tilt, Adjustable Lumbar Support, Tilt Tension

EM14623-3
 Mesh Back Manager's Chair
 24.5 x 22 x 39.25-43H
 Functions: Pneumatic Seat, 3-Position Locking Tilt, Adjustable Lumbar Support, Tilt Tension



Chrome Base



EMH6950CHR-3

Black Matrix Seat and Back Manager's Chair
28.5 x 26.5 x 46-52.5H

Functions: Pneumatic Seat, Locking Tilt, Adjustable Lumbar Support, 4-Way Adjustable PU Padded Flip Arms, Adjustable Headrest, Tilt Tension



Chrome Base



EMH60949C-3

Black Matrix Seat and Back Manager's Chair
26 x 24.75 x 40-43.75H

Functions: Pneumatic Seat, Locking Tilt, Adjustable Lumbar Support, PU-Padded Adjustable 4D Flip Arms, Tilt Tension



FLIP
arms

VENTILATED

SEATING



RLY26-WH White



FLiP
arms

RLY26

Riley Manager's Chair
27 x 26.5 x 37.5-41.25H
Functions: Pneumatic Seat, 2-to-1
Synchro Tilt, Padded Flip Arms, Tilt Tension
PATENT # US 29/553,650



WH White



BK Black



FLiP
arms

69906

Manager's Chair
27 x 26.5 x 37.5-41.25H
Functions: Pneumatic Seat,
2-to-1 Synchro Tilt,
Padded Flip Arms,
Tilt Tension
PATENT # US 29/553,650



2 Grey



3 Black



FLiP
arms



EM60926P-3M (Black Fabric)
EM60926P-U6 (Black Faux Leather)
Screen Back Manager's Chair
25.75 x 24.75 x 39-42.5H
Functions: Locking Tilt, Pneumatic Seat,
Tilt Tension, PU Padded Flip Arms



FLiP
arms

EM60926WH-U11

White Screen Back Manager's Chair
25.75 x 24 x 38.75-42.5H
Functions: Locking Tilt, Pneumatic Seat, Tilt Tension, PU Padded Flip Arms

EM51022N-3 | EM51022N-2 Grey

Mesh Back Task Chair
26.75 x 24.5 x 36.75-40.5H
Functions: *Pneumatic Seat,
Locking Tilt, Fixed
Designer Arms,
Tilt Tension,*



EM60946HR-3

Mesh Back Manager's Chair with Headrest
26.25 x 27.75 x 47.75-51.25H
Functions: *Pneumatic Seat,
Locking Tilt, Fixed Headrest,
Tilt Tension, PU Padded
Flip Arms*



EM60930C-EC3

Mesh Back Black Bonded
Leather Manager's Chair
28 x 25 x 41.25-44.25H
Functions: *Pneumatic Seat,
2-to-1 Synchro Tilt,
PU Padded
Adjustable Arms
Tilt Tension*



BIG & TALL

SEATING



Weight Capacity
400 lbs.



Weight Capacity
400 lbs.

A. 639-3T1763

Vertical Matrix Back Manager's Chair
29.75 x 26 x 41.5-48.5H

Functions: 2-to-1 Synchro Tilt, 3-Position Lock w/Anti-Kick Control, Seat Slider, Back Height Adjustment, Height-Width Adjustable Padded Arms

B. 639-T11763

Vertical Matrix Seat and Back Manager's Chair
29.25 x 26 x 41.25-48.25H

Functions: 2-to-1 Synchro Tilt, 3-Position Lock w/Anti-Kick Control, Seat Slider, Back Height Adjustment, Height-Width Adjustable Padded Arms



Weight Capacity
400 lbs.

69227-3M

Deluxe Fabric Mesh Executive Chair

29.5 x 28 x 43.5-47.25H

Functions: Pneumatic Seat, Locking Tilt, 2-Way Adjustable Flip Arms with 3 Adjustable Heights, Tilt Tension,



Weight Capacity
400 lbs.

75-77A753

Air Grid® Manager's Chair
29.5 x 25.25 x 42.25-46.5H

Functions: Pneumatic Seat, Deluxe 2-to-1 Synchro Tilt with 3-Position Lock, Tilt Tension, 2-Way Adjustable Arm Pads



69227-3M Detail



75-77A753 Detail

EC3
Black Bonded Leather



Has achieved GREENGUARD certification



C



C. ECH95297BT-EC3
Big and Tall Chair
27.75 x 32 x 45.5-48.75H
Functions: Pneumatic Seat,
Tilt Tension, Locking Tilt

Weight Capacity
350 lbs.

D. 63-11A653RHM
Air Grid® Manager's Chair
29.5 x 26.75 x 48.25-57H
Functions: 2-to-1 Synchro Tilt with
3-Position Lock, Adjustable Headrest,
2-Way Adjustable Arms w/PU Pads



D



63-11A653RHM
2-Way Adjustable Arms

Weight Capacity
400 lbs.

BIG & TALL

SEATING



63-37A773HM
Adjustable Lumbar Support



63-E37A773HL
Thick Padded Leather Seat



A. 63-37A773HM

Deluxe Air Grid® Back Manager's Chair
29 x 29.5 x 48.25-55.5H Patent# USD543398 S1
Functions: Mid-Pivot Knee Tilt, 2-Way Adjustable Arms w/PU Pads, Tilt Tension

B. 63-E37A773HL

Deluxe Air Grid® Back Manager's Chair
29 x 29.5 x 48.25-55.5H
Functions: Mid-Pivot Knee Tilt, 2-Way Adjustable Arms w/PU Pads, Tilt Tension



Weight Capacity 400 lbs.



C. 95894BT-R107

Dillon Black | Dillon
Mesh Back Large Occupant Chair
29 x 25.75 x 42.5-48H
Functions: Multifunction with Forward Tilt, Pneumatic Seat, Seat Slider, Tilt Tension, 2-Way Adjustable Padded Arms





EC3
Black Leather



ECH14517BT (Leather/Titanium Base)

EXH14517BT (Charcoal Fabric)

Big & Tall Executive Chair

27.5 x 29.5 x 45.25-49.25H

Functions: Locking Tilt, Pneumatic Seat,
Tilt Tension, Padded Flip Arms



Padded Flip Arms



Weight Capacity
400 lbs.

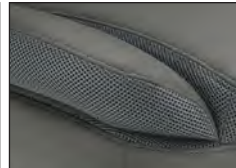
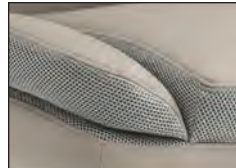

EC21
Titanium/Taupe



EXH14517BT-2
Titanium/Charcoal Fabric



EC42
Titanium/Charcoal Grey

BIG & TALL

SEATING



Fabric Seat

Weight Capacity
400 lbs.

75-37A773

Big & Tall Dual Layer
Dark Air Grid® Back
Ergonomic Chair
29.25 x 27 x 42.25-45H
Patent# USD540080 S1
Functions: Pneumatic Seat,
Adjustable Lumbar Support,
Mid-Pivot Knee Tilt, 2-Way
Adjustable Padded Arms,
Tilt Tension

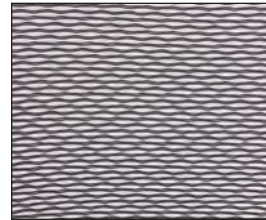

Bonded Leather Seat

Weight Capacity
400 lbs.



75-47A773

Big & Tall Dual Layer
Dark Air Grid® Back Ergonomic Chair
Patent# USD540080 S1
29.25 x 27 x 42.25-45H

Functions: Pneumatic Seat, Adjustable Lumbar
Support, Mid-Pivot Knee Tilt, 2-Way Adjustable
Padded Arms, Tilt Tension



Has achieved GREENGUARD certification



*Dillon Black
Antimicrobial Seat*

*Weight Capacity
400 lbs.*



75-A773-R107

Big & Tall Dillon Ergonomic Chair

29.25 x 27.75 x 42.25-45H

Patent# USD540080 S1

*Functions: Mid-Pivot Knee Tilt,
Pneumatic Seat, Adjustable Lumbar
Support, Tilt Tension, 2-Way
Adjustable Padded Arms*



NESTING/TRAINING

SEATING



69349-R107 Soft PU Padded Back Folding Chair (2-pack) 25.5 x 23 x 38H



new
SOFT-FLEX
frame

Weight
Capacity
275 lbs.

A. 69349-30
69349-R107

Soft PU Padded ProGrid® Back Folding Chair
Black EPD Finish (2-pack)
25.5 x 23 x 38H



new
SOFT-FLEX
frame

Weight
Capacity
275 lbs.

B. 69350-30
69350-R107

Soft PU Padded ProGrid® Back Armless
Folding Chair, Black EPD Finish (2-Pack)
25 x 23 x 38H



Weight
Capacity
250 lbs.

C. 84440-30
84440-R107

Deluxe Folding/Nesting Armchair w/ProGrid® Back
(2-pack), Titanium EPD Finish
25 x 24.25 x 36.25H



Weight
Capacity
250 lbs.

D. 84220-30

Deluxe Folding/Nesting Armless Chair
w/ProGrid® Back (2-pack), Titanium EPD Finish
24.75 x 24.25 x 36.25H

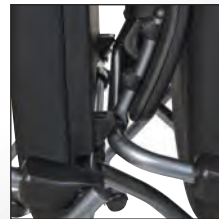

Back Flexes for Comfort
Horizontal Nesting

All items
on this
page are

2
PACK



30
FreeFlex® II Coal



R107
Dillon Black



Weight
Capacity
250 lbs.



2
PACK

E. 84330-30
Folding/Nesting Armchair
(2-pack), Titanium EPD Finish
25.25 x 23.25 x 34.75H
A: \$800 B: \$850 C: \$890 R: \$925



Weight
Capacity
250 lbs.



2
PACK

F. 83220-30
Deluxe Folding/Nesting Armchair w/ProGrid® Back
(2-pack), Titanium EPD Finish
25 x 24.25 x 36.25H
A: \$695 B: \$735 C: \$780 R: \$855



2
PACK

shown with
SFT4530
Nesting Tables;
see page 61.

G. FC8486-231 Silver EPD Finish (2-pack)
H. FC8483-231 Black EPD Finish (2-pack)
I. FC8487-231 Titanium EPD Finish (2-pack)
Flex Back Nesting Chair
24.5 x 22.75 x 35H



Flexible Back



Set of 2 Clips
for Ganging
Included



Seat Folds Up



Horizontal Nesting

- Breathable mesh back
- Black fabric seat or choice of Custom Fabric
- Carpet casters, two locking
- Ganging clips included
- Horizontal nesting





99583MDC-3
 Mesh Back Drafting Chair
 Polished Aluminium Base
 29 x 25.75 x 46.75-56H
Functions: Pneumatic Seat, Built-In Lumbar Support, PU-Padded Height Adjustable Arms, Height Adjustable Footring

ProGRID®



99583FDC-30 \$825

Mesh Back Drafting Chair
 Polished Aluminium Base
 29 x 26.25 x 46.75-56H
Functions: Pneumatic Seat, Built-In Lumbar Support, PU-Padded Height Adjustable Flip Arms, Height Adjustable Footring





AIR GRID®

13-37N20D
 Deluxe Dark Air Grid® Back
 Drafting Chair
 28.75 x 26.25 x 45.75-51H
 Fun Colors: \$640
 Dillon/B Fabric: \$655
 Functions: Pneumatic Seat,
 Adjustable Footring



13-37N20D-2M



AIR GRID®

15-37A720D
 Dual Layer Air Grid®
 Back Drafting Chair
 28.5 x 25.5 x 50.25-55.25H
 Functions: Pneumatic Seat,
 Adjustable Footrest



Weight Capacity
 325 lbs.

Has achieved GREENGUARD certification





ProGRID®

69340-30



30
FreeFlex® II Coal



10" Full
Cylinder Travel



69340-30

ProGrid® Drafting Chair

28.5 x 25.75 x 43.25-53.25H

A: \$450 B: \$475 C: \$515 R: \$565

Functions: Pneumatic Seat, Adjustable Footring



7.5" Intermediate
Cylinder Travel



69330-30

ProGrid® Drafting Chair

28.5 x 25.75 x 39.25-46.5H

A: \$450 B: \$475 C: \$515 R: \$565

Functions: Pneumatic Seat, Adjustable Footring



DC517V \$375 Ergonomic Drafting Chair

DC517V | Dillon:

DC517-231

Ergonomic Drafting Chair
23.5 x 22.75 x 38.5-48.5H

Functions: Pneumatic Seat, Back Height Adjustment, Seat Depth Adjustment, Adjustable Footring



Vinyl



231
Icon Black



10"
Seat Travel



DC2990-231

Deluxe Drafting Chair
28 x 22.75 x 41-52H
Functions: Pneumatic Seat, Back Height Adjustment, Seat Depth Adjustment, Adjustable Footring



231
Icon Black



10"
Seat Travel

DC2990V

Dillon:
Deluxe Drafting Chair
28 x 22.75 x 41-52H
Functions: Pneumatic Seat, Back Height Adjustment, Seat Depth Adjustment, Adjustable Footring



Vinyl



10.25"
Seat Travel



DC550-231

ProGrid® Drafting Chair
28.5 x 25.75 x 39.25-46.5H
Functions: Pneumatic Seat, Back Height Adjustment, Seat Depth Adjustment, Adjustable Footring

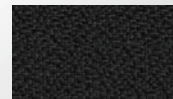

231
Icon Black

Has achieved GREENGUARD certification





EC6583

Executive High Back
Leather Chair

28.25 x 28.25 x 43.75-46.75H

Functions: Pneumatic Seat, Tilt
Tension, Locking Tilt



R105
Dillon Blue



R103
Dillon Stratus

EC4300
Executive Ergonomic Chair
26.75 x 25.75 x 42.75-48.25H
Functions: Pneumatic Seat,
Back Height Adjustment, Dual
Function, Height and Width
Adjustable Arms



R107
Dillon Black



Thick 4-ply
Foam-Padded Seat



Padded Adjustable
Flip Arms



ECH75137-EC2
(Titanium/Grey)

ECH75137-EC3
(Titanium/Black)

Leather Executive Chair
29 x 29.25 x 42.5-46.5H
Functions: *Pneumatic Seat,
Tilt Tension, Locking Tilt*



EC2 Grey

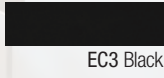

EC3 Black



FLIP
arms

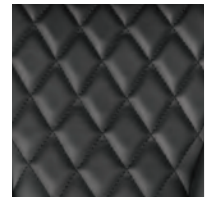

EXECUTIVE OFFICE

SEATING



FLIP
arms



ECH17051-EC21
Taupe Leather
in Cocoa Finish



ECH17057-EC42
Charcoal Grey Leather
in Titanium Finish



ECH17056-EC3
Black Leather
in Silver Finish



ECH17051-EC21 | ECH17056-EC3 | ECH17057-EC42

Executive Bonded Leather Chair 28.5 x 26.75 x 45.75-49.5H Functions: Locking Tilt, Pneumatic Seat, Tilt Tension, Padded Flip Arms



Contoured Leather
Seat & Back



Padded Adjustable
Flip Arms

ECH620867-EC2
(Titanium/Grey)
ECH620867-EC3
(Titanium/Black)
ECH620867-EC21
(Titanium/Taupe)
Leather Executive Chair
30.75 x 31.25 x 47.75-50.75H
Functions: Pneumatic Seat,
Tilt Tension, Locking Tilt



EC2 Grey EC3 Black EC21 Taupe



E. EC9231-EC3
Executive Mid-Back Chair
26.25 x 27.25 x 38-41.75H
Functions: Pneumatic Seat, Tilt Tension, Locking Tilt



F. EC9235-EC3
Executive Visitor's Chair
26.75 x 29 x 38.75H



D. EC9230-EC3
Executive High Back Chair
28.25 x 28.5 x 42-45.5H
Functions: Pneumatic Seat, Tilt Tension, Locking Tilt



ECH38615A-EC1 (Cocoa/Espresso)
ECH38665A-EC3 (Silver/Black)
Executive Chair
28.25 x 30 x 44.75-48.5H
Functions: Pneumatic Seat, Tilt Tension, Locking Tilt



EXECUTIVE OFFICE

SEATING



A

A. 8511-231

High Back Ergonomic Chair
in Titanium EPD Finish Base
28.25 x 24 x 44.75-48.25H

B. 8512-231

Mid-Back Ergonomic Chair
in Titanium EPD Finish Base
28 x 25 x 38-44.25H
*Functions: Pneumatic Seat, Ratchet Back
Height Adjustment, Height & Width Adjustable
Padded Arms, Multi Function, Tilt Tension,
Forward Tilt, Seat Slider*



231
Icon Black



shown in R101
Dillon Snow



B

shown in R107
Dillon Black



C

shown in 227
Icon Burgundy

C. 33347

High Back Ergonomic Chair
26.5 x 24.75 x 37.5-42.25H
*Functions: Pneumatic Seat,
Ratchet Back Height
Adjustment, Height & Width
Adjustable Padded Arms, Dual
Function w/Adjustable Tilt
Tension*

30 FreeFlex II® Coal



D. 3121-231

Mid-Back Ergonomic Chair
 28 x 25 x 37.5-41H
 Functions: Pneumatic Seat,
 2-to-1 Synchro Tilt,
 Height and Width
 Adjustable Arms,
 Tilt Tension



231
 Icon Black



D

shown in R106
 Dillon Sage



E

shown in K008
 Twilight Cotton

E. 43808-231



231
 Icon Black

Mid-Back Ergonomic Chair
 27 x 24 x 36.25-42.25H
 Functions: Pneumatic Seat,
 Ratchet Back Height
 Adjustment, Height Adjustable
 Padded Arms, Multi Function,
 Tilt Tension, Forward Tilt



SPECIALTY SPX Series

SEATING



U1 Espresso Faux Leather

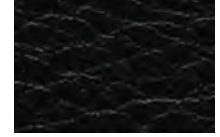

U6 Black Faux Leather



U9 Red Faux Leather

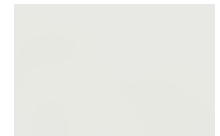

U11 White Faux Leather



U42 Charcoal Grey Faux Leather

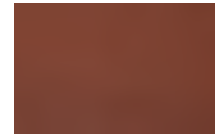

U41 Saddle Faux Leather



A

A. SPX23590C
High Back Manager's Faux Leather Chair
28.75 x 25.25 x 42-46H
Patent# D102568
Functions: Pneumatic Seat, Tilt Tension, Locking Tilt



B

B. SPX23591C
Mid-Back Manager's Faux Leather Chair
27 x 23.5 x 37-40.75H
Patent# D102568
Functions: Pneumatic Seat, Tilt Tension, Locking Tilt



C

C. SPX23592C
Armless Manager's Faux Leather Chair
20.5 x 23.5 x 37.25-41H
Patent# D102568
Functions: Pneumatic Seat, Tilt Tension, Locking Tilt



D

D. SPX23595C
Guest Faux Leather Chair
23.25 x 24.5 x 37.75H

Patent# D102568



Removable Matching Sleeves



Chrome Finish Loop Arms



Thick Contoured Seat & Back

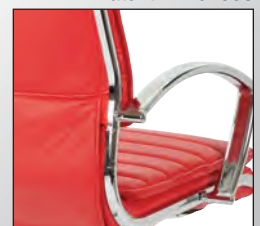

Chrome Accents



E. FL80287C
 Faux Leather Chair
 with Flip Arms
 24.5 x 26.5 x 38.25-41.75H
 Functions: Pneumatic Seat,
 Tilt Tension, Locking Tilt



- 
U6 Black
Faux Leather
- 
U9 Red
Faux Leather
- 
U11 White
Faux Leather
- 
U28 Cream
Faux Leather



Padded Arms Chrome Arms. Faux Leather
 Seat and Back

F. FL92011C-U6
 Low Back Executive Chair
 23 x 26.75 x 36.25-38.75H
 Functions: Pneumatic Seat,
 Tilt Tension, Locking Tilt

- 
U6 Black Faux Leather



G. FL92017C-U6
 Executive Chair
 23 x 26.5 x 40-43H
 Functions: Pneumatic Seat,
 Tilt Tension, Locking Tilt



H. FL38610C
 Chrome Frame
I. FL38610
 Black Frame
 Faux Leather
 Guest Chair
 25.5 x 25 x 35H

- 
U6
Black Faux Leather
- 
U11
White Faux Leather
- 
U42
Charcoal Grey Faux Leather



Chrome Frame with Radial-Style,
 Polypropylene Arms



Thick Padded Faux Leather
 Seat and Back



J. FL38640
 Black Frame
 *available only
 in -U6

K. FL38640C
 Chrome Frame
 Faux Leather Guest Chair
 with Casters
 25.5 x 25 x 34.5H



F AUX LEATHER

SEATING



U6
Black Faux Leather



FL14570
High-Back Faux Leather Executive Chair
Titanium Base
24.75 x 29.25 x 44-47H
*Functions: Pneumatic Seat, Locking Tilt,
Padded Arms, Tilt Tension*



U41
Saddle Faux Leather



FL14571
Mid-Back Faux Leather
Executive Chair
Titanium Base
24.75 x 25.25 x 39.5-42.5H
*Functions: Pneumatic Seat,
Locking Tilt, Padded Arms,
Tilt Tension*





Thick Padded Faux Leather
Contoured Seat & Back

FLH24981-U1

FLH24987-U6

Manager's Mid-Back Chair

28.25 x 26.25 x 41-44H

Functions: *Pneumatic Seat,
Locking Tilt, Padded Flip Arms,
Tilt Tension*



FLiP
arms

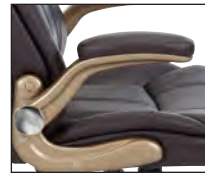

U6
Black
Faux Leather
Silver Base



U1
Espresso
Faux Leather
Cocoa Base



F AUX LEATHER

SEATING



PU Padded Loop Arms



U6
Black
Faux Leather



U21
Taupe
Faux Leather



U42
Charcoal Grey
Faux Leather



FL13785-U42
FL13785-U21
Faux Leather Manager's Chair
28.5 x 27.75 x 42.25-46H
Functions: *Pneumatic Seat,
Tilt Tension, Locking Tilt*



FL660-U2 / FL660-U6 / FL660-U42
 Manager's Chair
 28.25 x 26.25 x 41-44H
 Functions: Pneumatic Seat,
 Tilt Tension, Locking Tilt

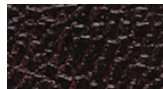

U2
 Chocolate
 Faux Leather



U6
 Black
 Faux Leather



U42
 Charcoal Grey
 Faux Leather



PU Padded
 Loop Arms



FL91201-U2 / FL91201-U6 / FL91201-U42
 Mid-Back Faux Leather Manager's Chair
 27.75 x 26.25 x 37.25-40.75H
 Functions: Pneumatic Seat,
 Locking Tilt, Padded Flip Arms, Tilt Tension

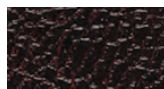

U2
 Chocolate
 Faux Leather



U6
 Black
 Faux Leather



U42
 Charcoal Grey
 Faux Leather

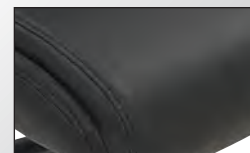

Faux
 Leather Seat
 and Back



JT4
Jamestown
Vinyl

TEX234
Traditional Queen Anne Style Chair
29.25 x 31 x 40.75H



Black
Vinyl

TWN300L
Top Grain Leather Executive Chair
28.5 x 30 x 44.75-46.5H
Functions: Pneumatic Seat, Tilt Tension, KneeTilt



3
Black Vinyl

TEX280
High Back Traditional Executive Chair
29 x 32 x 47-49.75H
Functions: Pneumatic Seat, Tilt Tension, Locking Tilt



TV230
Traditional Guest Chair
25.25 x 24.25 x 30.75H

JT4
Jamestown
Vinyl
3
Black Vinyl



TV231
Traditional Guest Chair
with Casters
26 x 24.25 x 30.75H



TEX228
 Deluxe High Back
 Traditional Executive Chair
 28.75 x 29.75 x 47.5-50.25H
 Functions: Pneumatic Seat, Tilt
 Tension, Locking Tilt

JT4 3
 Jamestown Black
 Vinyl Vinyl



TEX220
 Deluxe High Back
 Traditional Executive Chair
 29.75 x 30.25 x 43-45.75H
 Functions: Pneumatic Seat, Tilt
 Tension, Locking Tilt

JT4
 Jamestown
 Vinyl

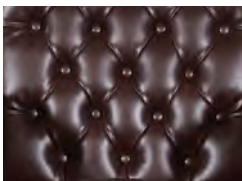

Tufted Back

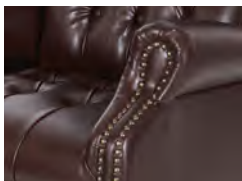

Padded Arms



Brass Finish Nail Trim



Royal Cherry Finish Wood
 Covered Steel Base

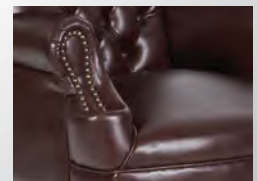

Thick Padded Seat and Back

GUEST / VISITOR

SEATING

85670-30

ProGrid® Back Deluxe
Stacking Visitors Chair
Titanium EPD Finish
24.5 x 23.25 x 37.75H



STACKS
4



85640-30

ProGrid® Back Deluxe
Guest Chair with Casters
Titanium EPD Finish
24.5 x 23.25 x 37.75H

ProGRID®



STACKS
4

84510-30
84510-R107

ProGrid® Back Deluxe Stacking Visitors Chair
Titanium EPD Finish
25.5 x 24 x 36.5H



84540-30 84540-R107

ProGrid® Back Deluxe Guest Chair with Casters
Titanium EPD Finish
24.5 x 23.25 x 37.75H



30
FreeFlex® II Coal

R107
Dillon Black



88710C-30

Guest Chair Silver EPD Finish
26 x 25.5 x 36.75H

STACKS
4





A



A. 86724R-30

ProGrid® Back Deluxe
Stacking Visitor's Chair
Titanium EPD Finish
20.25 x 24 x 33.25H

ProGRID®

- Breathable ProGrid® back
- Stocked in FreeFlex® Coal (30)
- Available in Custom Fabric
- Titanium finish frame



30
FreeFlex® II Coal



B

B. 86725R-30

ProGrid® Back Deluxe
Visitor's Chair
Titanium EPD Finish
20.25 x 23.5 x 33H



C



shown 86710R-R100 in Dillon Lipstick

C. 86710R-30

ProGrid® Back Deluxe
Stacking Visitors Chair
Titanium EPD Finish
24 x 23 x 34H



86740R-30

D. 86740R-30

ProGrid® Back Deluxe
Stacking Visitors Chair
with Casters
Titanium EPD Finish
25 x 23 x 34H



Has achieved GREENGUARD certification



GUEST / VISITOR

SEATING



V4410-231



V4420-231

Sled Base Armless Visitor's Chair
Black EPD Finish
24 x 24.25 x 34.25H



231
Icon Black

Sled Base Visitor's Chair
Black EPD Finish
24 x 24.25 x 34.25H

STC3410

4-Leg Armchair
Black EPD Finish
24.25 x 24.75 x 33.25H



FL10274
Visitor's Chair
23.5 x 24.25 x 33.5H



83710B-231
83710B-R107

Visitor's Chair
Black EPD Finish
24.5 x 24.25 x 34H



83720-231
83720-R107

Armless Visitor's Chair
Black EPD Finish
21.75 x 24.25 x 34H



231
Icon Black



R107
Dillon Black



Has achieved GREENGUARD certification



U42 Charcoal Grey Faux Leather U6 Black Faux Leather U11 White Faux Leather

A. THP
 M78 Charcoal/Faux Leather:
 Grade A: Dillon:
 Lounge Chair with
 Chrome Finish Sled Base
 26 x 27.75 x 32.5H



U6 Black U41 Saddle U42 Charcoal Grey

B. FLH5974BK
 Faux Leather Swivel Chair
 27.5 x 27.5 x 30H



C. STC8302C2 (2-pack)
STC8302C4 (4-pack)
STC8302C28
 (28-pack, ships with DOL8302 Dolly)
 Stacking Chair in Silver EPD
 Finish Steel Sled Base
 19 x 19.5 x 31.5H

D. STC8300C2 (2-pack)
STC8300C4 (4-pack)
STC8300C28 (28-pack)
 (28-pack ships with DOL8300 Dolly)
 Stacking Chair in Silver EPD Finish Steel Frame
 19 x 19.5 x 31.5H



3 Black 11 White

- Black plastic seat and back
- Available in 2, 4 or 28-pack
- Stacking and ganging

- Silver EPD finish steel sled base
- Stacking dolly available



GUEST / VISITOR

SEATING



3
Black



STC865C2-3 (2-pack)
STC865C4-3 (4-pack)
STC865C30-3
 (30-pack, ships with Dolly)
 Stacking Chair in Silver EPD
 Finish Steel Sled Base
 19 x 23 x 34H



A

A. DC8658C2 (2-pack)
DC8658C4 (4-pack)
 Tall Stacking Chair in Silver EPD
 Finish Steel Frame
 22 x 25 x 46H

B. DC8309C2 (2-pack)
DC8309C4 (4-pack)
DC8309C25
 (25-pack, ships with Dolly)
 Tall Stacking Chair in Silver EPD
 Finish Steel Frame
 20.25 x 22.75 x 43.75H



3
Black



11
White



B



88657C2-30 (2-pack)
88657C4-30 (4-pack)
88657C23-30 (23-pack w/Dolly)
 Tall Stacking Visitor's Chair
 in Silver EPD Finish Sled Base
 22.5 x 25.25 x 45.25H

88657C2 (2-pack)
88657C4 (4-pack)
88657C23 (23-pack w/Dolly)

8455C2-30 (2-pack)
8455C4-30 (4-pack)
8455C20-30 (20-pack w/Dolly)
 Stacking Chair w/Ventilated Plastic Back
 in Silver EPD Finish Sled Base
 20.25 x 24 x 33.25H

8455C2 (2-pack)
8455C4 (4-pack)
8455C20 (20-pack w/Dolly)

All chairs below with Titanium EPD Finish



8610-30

STACKS 4
 Ventilated Wrap Around Back
 Deluxe Stacking Visitor's Chair
 24 x 23 x 34H



8640-30

STACKS 2
 Ventilated Wrap Around Back
 Deluxe Stacking Visitor's Chair
 with Casters
 24 x 23 x 34H



Mixed Stack 8640, 8620, 8610

STACKS 4
8620-30

Ventilated Wrap Around Back
 Deluxe Armless Stacking
 Visitor's Chair
 20.5 x 23 x 34H



F
 CUSTOM FABRIC
30
 FreeFlex® II Coal

GUEST / VISITOR

SEATING



A

A. 55094S

Big & Tall Guest Chair
27 x 29.5 x 34.5H
300 lbs. weight capacity

55094S
Shown in
K018
Ridgecrest
Putty



B. 55099S

Big & Tall Guest Chair
31 x 29.5 x 34.25H
500 lbs. weight capacity
Shown in Dillon Black -R107

55099S Shown in R111 Dillon Graphite



55094S
Shown in R108 Dillon Ocean



55099S Shown in
R113 Dillon Luggage



Has achieved GREENGUARD certification



55054B-231

Big & Tall Armless Guest Chair
24.75 x 24.5 x 33H
500 lbs. weight capacity



55052B-231

Big & Tall Guest Chair
Dillon or Castillo: \$695
28 x 24.75 x 33H
400 lbs. weight capacity



231
Icon Black



Shown in K039 Key Largo Palm



55051B-231

Big & Tall Guest Chair
32.75 x 24.75 x 33H
500 lbs. weight capacity

Self-Skinned Urethane Chairs



KH813037
 Task Chair
 28 x 26 x 32.25-40.25H
 Pneumatic Seat, Height
 Adjustable Arms & Back, Seat
 & Back Angle Adjustment



KH503
 Intermediate Stool
 25.25 x 22.5 x 17.25-24.75H
 Pneumatic Seat

7.5"
 Seat Travel



KH81313CX
 Drafting Chair
 26.75 x 23.5 x 40.25-56.5H
 Pneumatic Seat,
 Height Adjustable Back,
 Fixed Footrest,
 Interchangeable Glides

9.75"
 Seat Travel



KH81375MX
 Intermediate Stool
 29 x 27.25 x 35.25-45H
 Pneumatic Seat, Height
 Adjustable Back



Adjustable Footrest



KH81313
 Armless Task Chair
 25.25 x 22.5 x 17.25-24.75H
 Pneumatic Seat, Height
 Adjustable Back



Has achieved GREENGUARD certification



KH81393
Guest Chair
24.25 x 22.25 x 33.75-36H



KH81391
Armless Guest Chair
21 x 23 x 33.75-36H

Features

- Contoured self-skinned urethane seat and back
- Height adjustable back
- Black EPD finish
- Contoured polypropylene armrests



KH81392
Guest Chair with Casters
24.25 x 22.25 x 33.75-36H



Folding Tables and Chairs



- Durable construction
- Powder coated steel tubular frame
- Easy storage
- Light weight sleek design
- Ideal for indoor or outdoor use

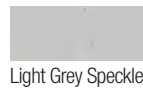

PC-02
Resin Folding Chair
(4-pack)
18.5 x 22 x 33.25H



Weight Capacity 300 lbs.

PC-03
Resin Folding
Chair (4-pack)
18.5 x 22 x 33.25H



**Resin MultiPurpose
Rectangular Tables**

- BT04Q** 48 x 24 x 29.25H
- BT06Q** 72 x 30 x 29.25H
- BT6FQ** 72 x 29.5 x 28.75H
- BT08Q** 96 x 30 x 29.25H

Resin MultiPurpose Round Tables

- BT48Q** 36 Dia. x 29.25H
- BT60Q** 60 Dia. x 29.25H



QT7894
Folding Beverage
Ice Cooler Table
47.25 x 23.75 x 32H



TC103
Caddy for PC-02, PC-03
34.5 x 18.75 x 74.75H



FC8100NS-7
Silver/Blue



FC8100NS-3
Silver/Black



FC8100NP-3
Black/Black



Ganging

4
PACK

FC8100 Series
Folding Chair (4-pack)
19.25 x 21.5 x 35.5H

- Ventilated plastic fan back •
- Padded fabric seat •
- Stacking and ganging •



FC8000NB-1
Mocha/Mocha



FC8000NB-11
Beige/Beige

FC8000NP-3
Black/Black

FC8000NS-2
Silver/Grey

FC8000NS-7
Silver/Blue

- Ventilated plastic seat and back
- Stacking and ganging

- Meets or exceeds test standards to 300 lbs. or less

- PATENT # US D647,718 S

4
PACK

FC8000 Series
Folding Chair (4-pack)
19 x 20.5 x 32H



ganging



stacking





Choices in Fabric.

Wherever chairs are identified with our CF graphic, you have hundreds of choices in fabric. Solids, patterns and textures. Simple and complex. Vinyls. Hospitality/healthcare-safe performance fabrics. Recycled selections. Choices for every environment. Many are IN-STOCK. You can also choose C.O.M. (customer's own material). Digital representations of fabrics are available at www.officestar.net **Custom Fabrics require additional lead time.**

grade A fabric

Linen



Colored Mesh

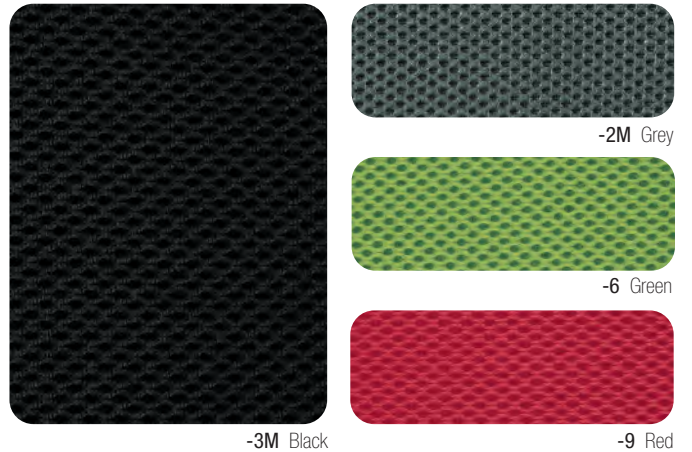

Ridgecrest

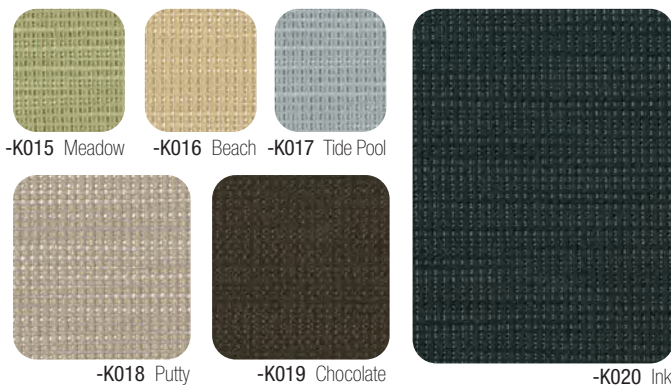

Interlink

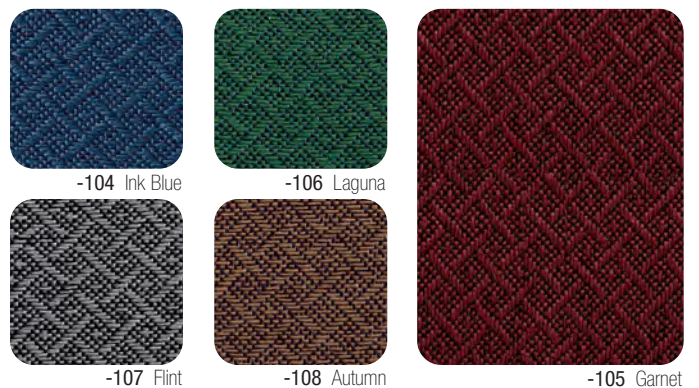

Icon

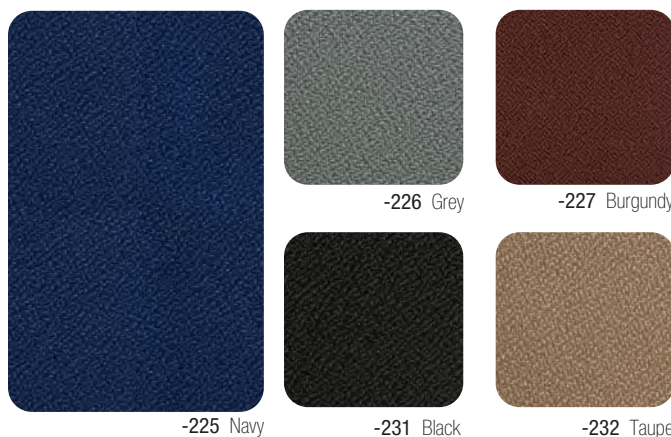

Diamond

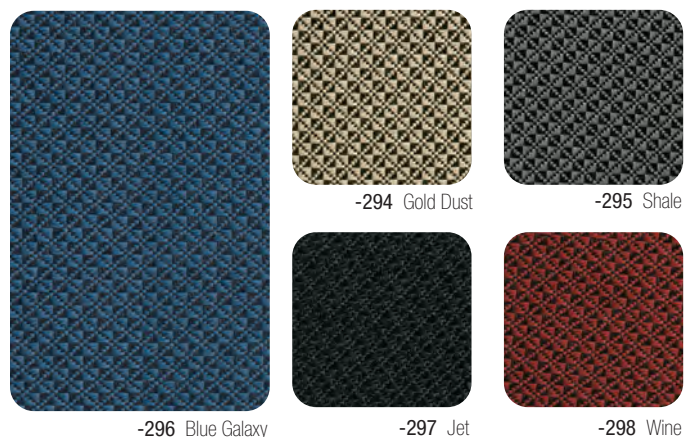

grade **B** fabric

Twilight



Dillon

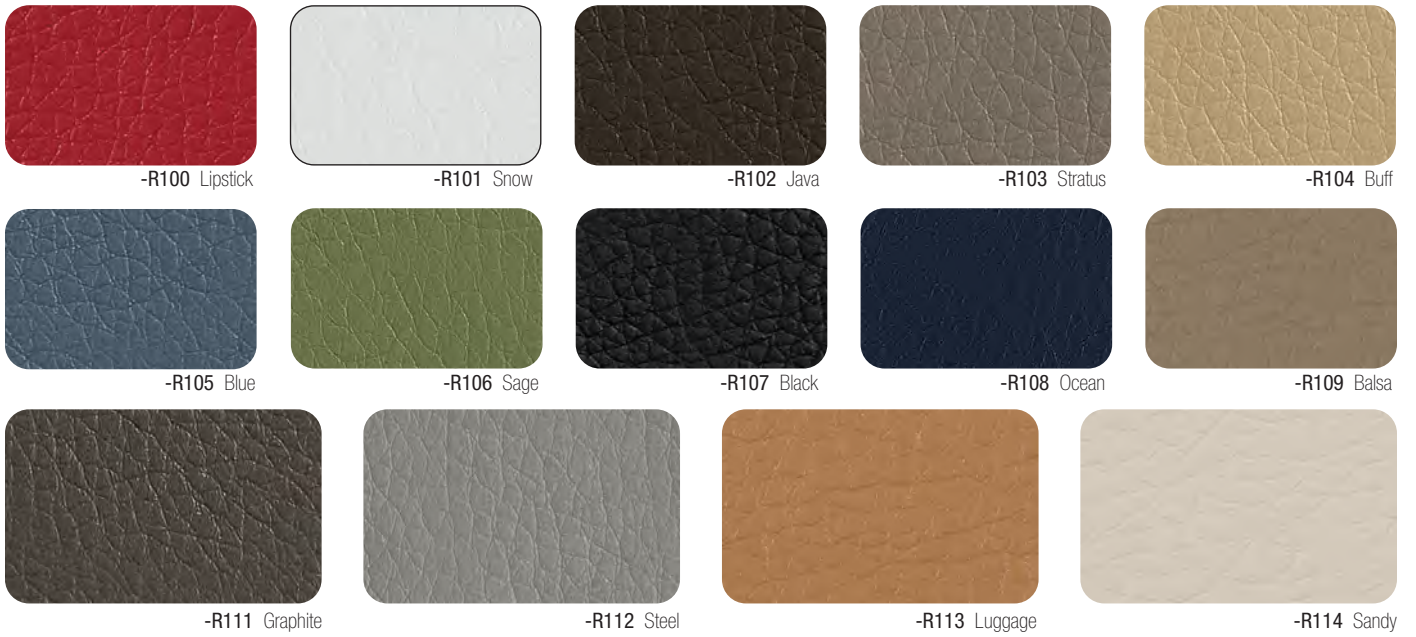

Fine Tune

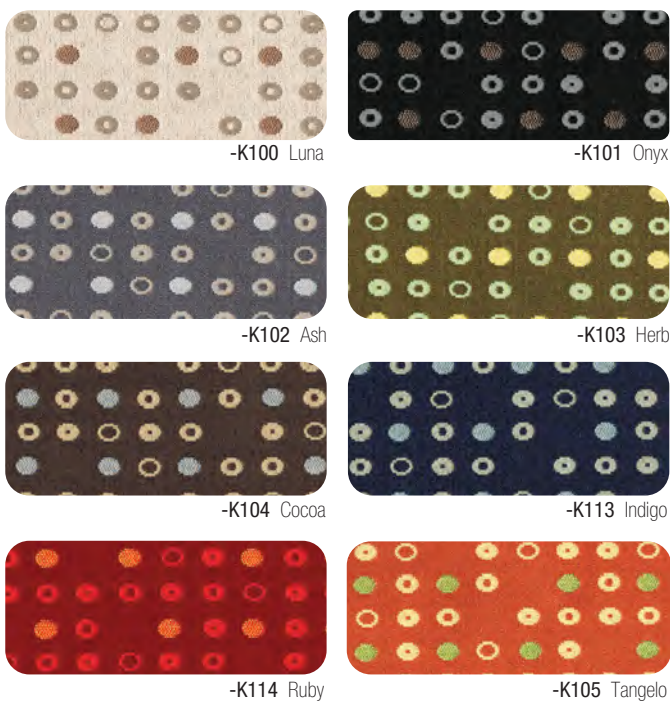

Castillo



grade **B** fabric

City Park



-K106 Birch

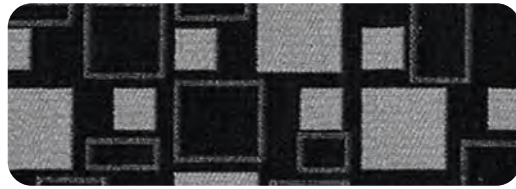

-K107 Domino



-K108 Steely

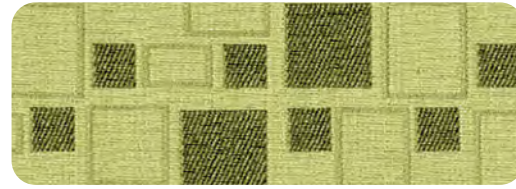

-K109 Kiwi



-K110 Walnut



-K111 Marigold



-K115 Tomato

Transport



-216 Tuxedo

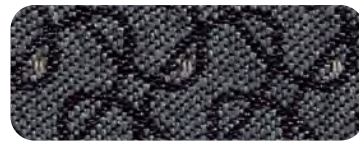

-217 Ash

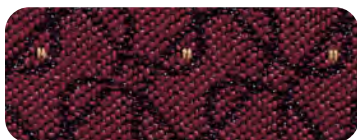

-218 Inferno

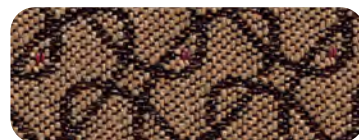

-220 Nugget



-214 Ivy



-215 Rapids

FreeFlex® II



-9201 Carbon/Grey

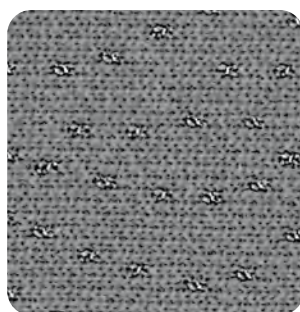

-9211 Ember



-9214 Azul



-30 Coal

grade **C** fabric

*recommended for lounge seating **Tracery**

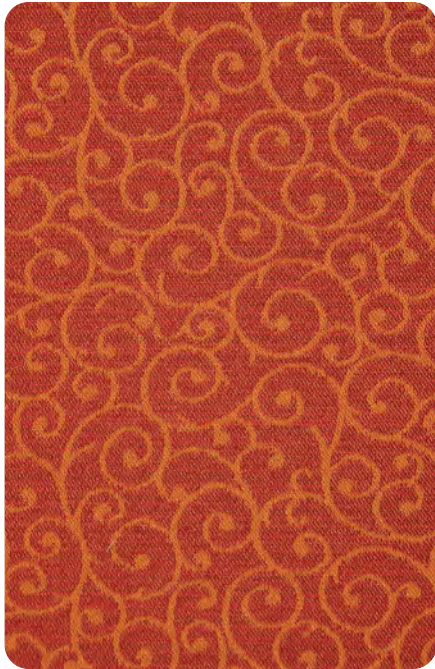

-K026 Persimmon

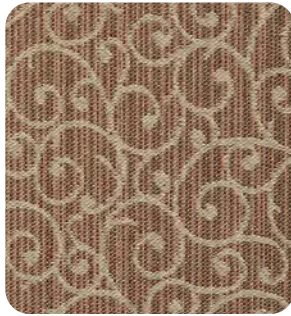

-K021 Khaki



-K022 Chestnut



-K023 Taupe



-K024 Azure



-K025 Golden

Couture

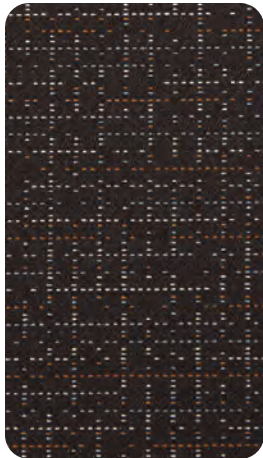

-K056 Seam

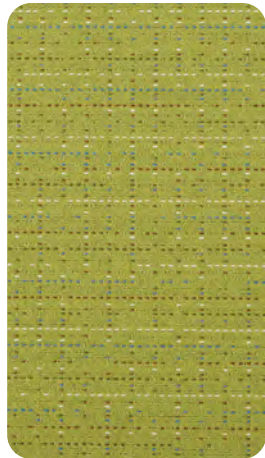

-K055 Thread



-K054 Thimble

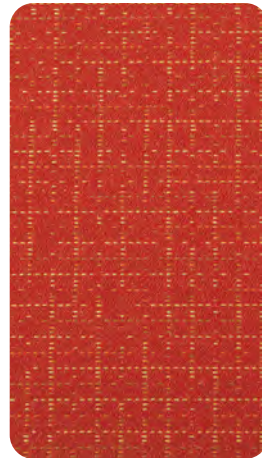

-K053 Basting



-K052 Tailor

grade **R** fabric

Key Largo



-K038 Chocolate



-K039 Palm



-K040 Aqua



-K041 Sand

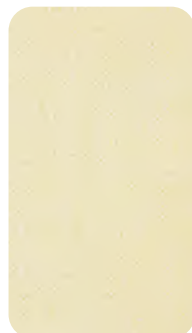

-K042 Parchment



-K043 Tangerine



2026



Surplus Office Sales

2131 S Hellman Ave Suite S Ontario, CA 91761

Phone: (909) 947-7770 Fax: (909) 947-4137

www.surplusofficesale.com surplusofficesales@gmail.com

Great Talent

Deserves Great Offices